

Gabarrón



RXE Plus

THERMAL RADIATORS

RX4E Plus

RX10E Plus

RX6E Plus

RX12E Plus

RX8E Plus

RX14E Plus

Please read these instructions before installing or using this appliance for the first time. These instructions must be followed for the safe installation of the radiator. Any problem, fault or damage caused by the non-observance of these instructions will not be covered under the manufacturer's warranty. This manual should be retained with the appliance by the user for future reference.

I.- WARNING Please read these instructions before installing or using this appliance for the first time.

- The warranty of the heater will not cover any damage caused by non-observance of any of these instructions.
- The instructions should be retained for future reference. This guide must be kept and given to any new owner.
- This appliance can be used by children aged from 8 years and above and persons with reduced physical, sensory or mental capabilities or lack of experience and knowledge if they have been given supervision or instruction concerning the use of the appliance in a safe way and understand the hazards involved. Children must not play with the appliance. Cleaning and user maintenance must not be made by children without supervision.
- Children aged from 3 years and less than 8 years shall only switch on/off the appliance provided that it has been placed or installed in its intended normal operating position and they have been given supervision or instruction concerning use of the appliance in a safe way and understand the hazards involved. Children aged from 3 years and less than 8 years shall not plug in, regulate and clean the appliance or perform user maintenance.
- Children of less than 3 years should be kept away unless continuously supervised.
- Please check that the voltage in the rating label fits the power supply.
- The use of these heaters is forbidden in any area where there is a presence of gases, explosives or inflammable objects.
- Do not use this heater to dry clothes. Do not cover this heater or put objects in contact with it.
- Neither the connecting cable nor any other object must come into contact with the hot unit.
- Do not cover this heater at any time.
- The air outlet at the top of the thermal radiator and the air inlet at the bottom are provided to ensure the most efficient operation of the appliance. They also protect the heater from overheating; therefore, it is essential that at no time are they covered.
- This heater should be switched off at the isolating switch before any repair work is carried out.
- The installation must be carried out in accordance with the current electrical regulations.
- Should the heater be moved and reinstalled it is essential that the work is carried out by a fully qualified technician.
- The heater should not be installed just below an electrical socket.
- The appliance must be installed in such a way that it is impossible for anyone using a bath or shower, to touch the controls.
- The heater is fitted with a flexible cable size $3 \times 1.00 \text{ mm}^2$ for electrical connection. It may be used to connect the heater to the fixed wiring of the premises through a suitable connection box positioned adjacent to the heater.
- The supply circuit to the heater must incorporate a double pole isolating switch having a contact separation of at least 3 mm.
- If the flexible power cable for this unit is damaged, it may only be replaced by a repair workshop recognised by the manufacturer, as special tools are necessary.
- This appliance must be earthed.
- All models are supplied with an electrical interrupt cut-out. This will switch off the heater if, for any reason, it overheats. Should the cut-out operate, turn the heater off and remove the cause for the overheating. The cut-out will be reset automatically.
- The presence of air particles of smoke, dust and other pollutants could, in time, discolour the walls and surfaces around the heater.
- CAUTION — Some parts of this product can become very hot and cause burns. Particular attention must be given when children and vulnerable people are present.

2.- INSTALLATION INSTRUCTIONS

- Open the package and check that it is the correct model and it is in good condition.
- To obtain optimum performances it is necessary to maintain a minimum clearance of 15 cm between the radiator and any inflammable material as furniture, curtains etc.
- The rest of clearances required to maintain are indicated on the following figure:

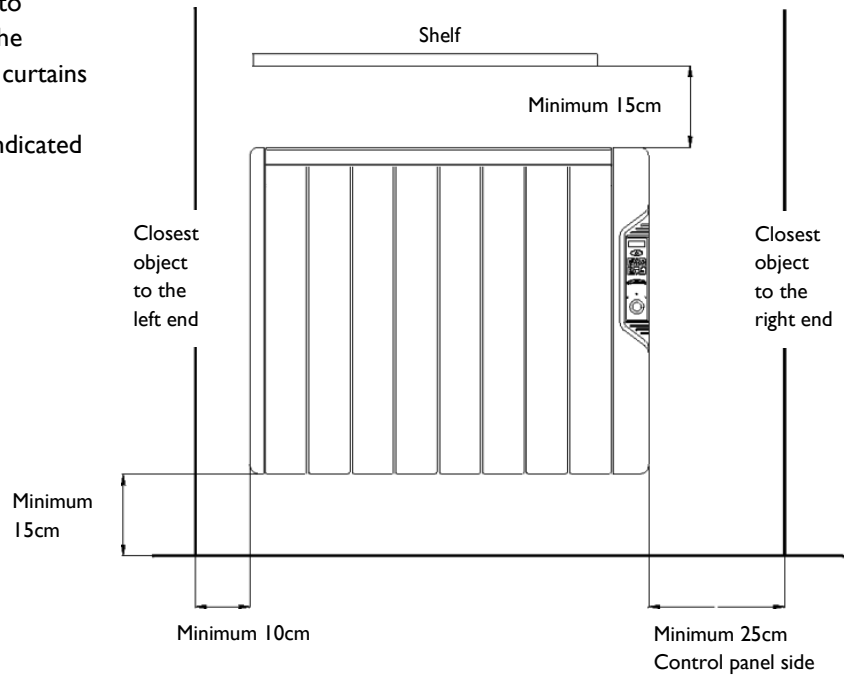

Position and fix the brackets at the correct distance from the floor. It is possible to use the radiator as measuring unit by positioning it on two polyester package elements and placing two supports above as indicated on the figure:

Mark the fixing points on the wall using a pencil through the two fixing holes in the square brackets and perform corresponding bores.

- The studs and screws to attach the supports are in the accessories bag.
- Hang the unit on the hooks of the brackets.
- By turning the screws, the metallic square will go downwards, retaining the heater. Repeat this on the other bracket.

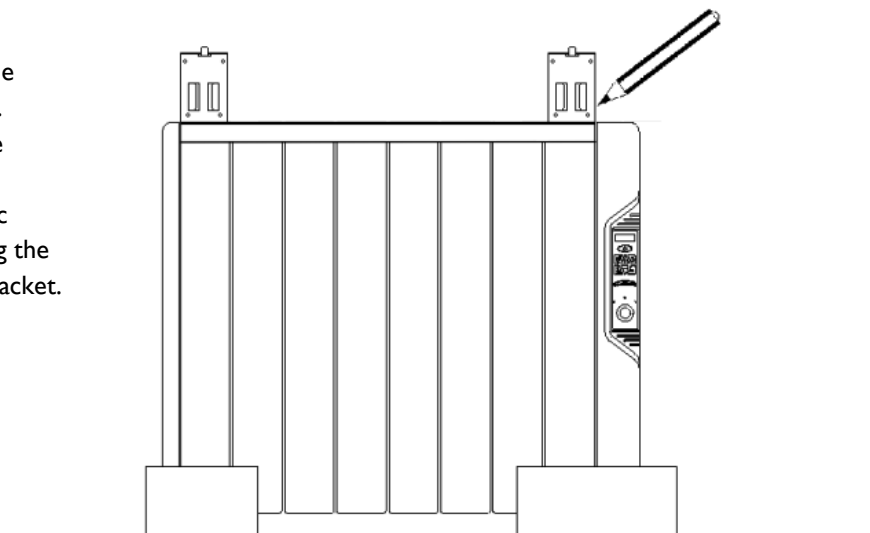

3.- USING THE THERMAL RADIATOR



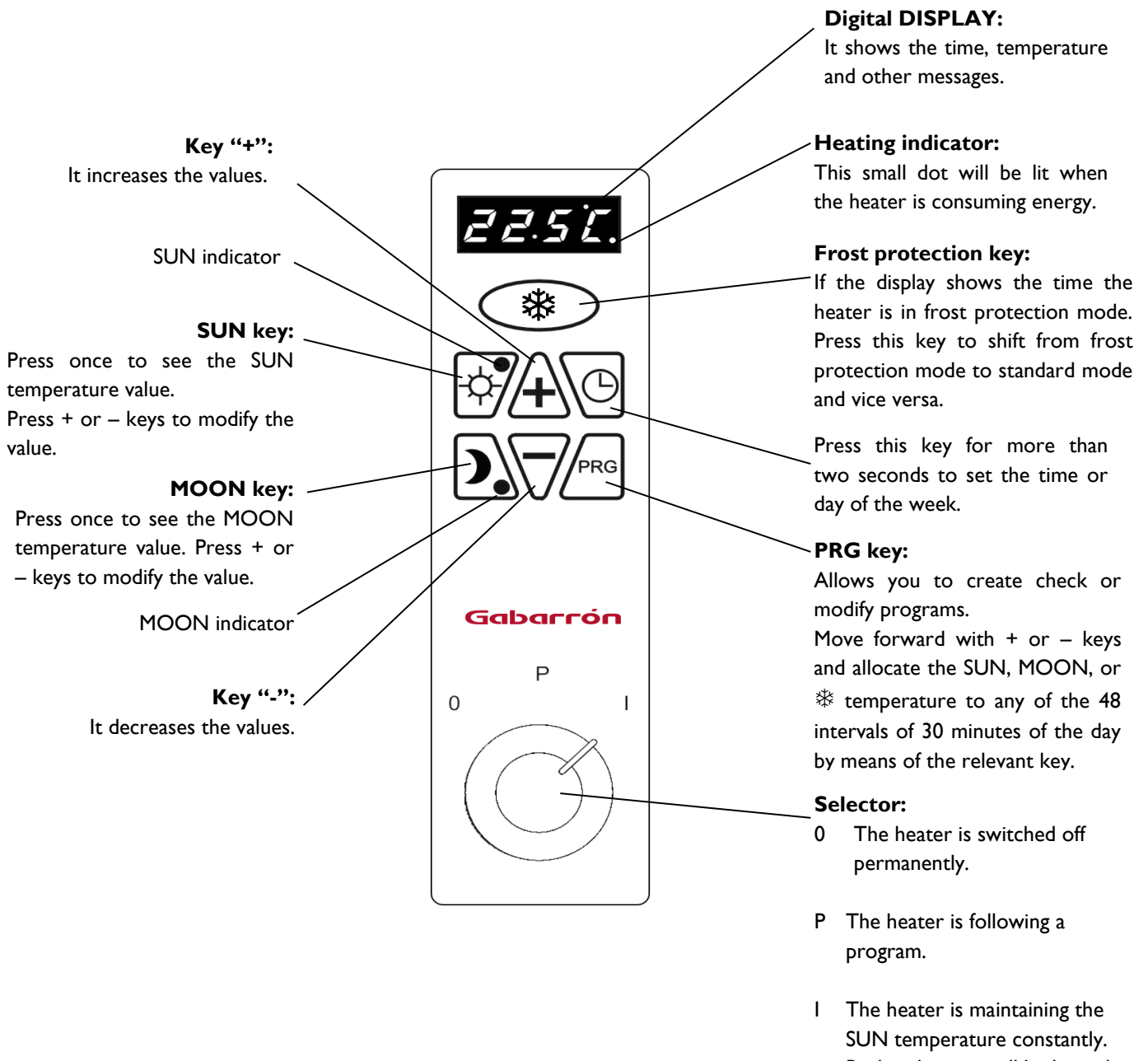

DIGITAL CONTROL WITH DAILY AND WEEKLY PROGRAMMING



RXE Plus models have built in an electronic thermostat with a sensibility of 0.1 °C. It is possible to set temperatures with an accuracy of 0.5°C.

The daily or weekly programmer (selectable) allows you to allocate three different temperature levels to any of the 48 intervals of 30 minutes of the day.

SWITCHING ON THE HEATER AND SETTING THE TIME

Turn the mode selector dial to P position and press the  key more than two seconds. The display will show the time intermittently. Set the hours by pressing + and - keys and press the . Set the minutes the same way. Press once more the  key to store the time. If at any time it is necessary to set the time press the  key and repeat the above steps.

FROST PROTECTION MODE

With this mode on, if the room temperature drops below 3°C the heater will connect itself automatically.

If the display shows the time the heater is in frost protection mode. Press the  key to shift from frost protection mode (time is shown in the display) to standard mode (temperature is shown in the display) and vice versa.

SELECTOR “O”, “P”, “I”.

Position “O”: The heater is switched off permanently. The display is switched off.



Position “P”: The heater is following a program. It will maintain the SUN, MOON or  temperatures as per the introduced program. At this position if the display shows the time the heater is frost protection mode.

Position “I”: The heater is maintaining the SUN temperature constantly both luminous indicators SUN and MOON will be lit. This could be useful when SUN temperature is required and we do not want to modify the program. At this position if the display shows the time the heater is in frost protection mode. Press the  key to shift from frost protection mode (time is shown in the display) to standard mode (temperature is shown in the display) and vice versa.

SUN, MOON AND TEMPERATURES

The electronic programmer is able to handle three temperature levels during the 24h of the day.

Press the  key to set the SUN temperature. The display will show the SUN temperature value blinking.

Set the SUN temperature value by means of the + o - keys and press the  key to store the value. If the display shows the time the heater is in frost protection mode. Press the  key to shift from frost protection mode (time is shown in the display) to standard mode (temperature is shown in the display) and vice versa.

Repeat the above steps with the key  to set the MOON temperature.





The  temperature level is 3°C and it is a fix value. This temperature level can be used as off selection when setting the temperatures during certain times of the day.



SUN, MOON, or  temperatures can be allocated to any of the 48 intervals of 30 minutes of the day.

DAILY PROGRAMMES

It is basic to visualize the day split into 48 intervals of 30 minutes each; SUN, MOON, or  temperatures can be allocated to any of them.

The default settings include daily mode so that the heater will repeat the program every day. If different programmes are required along a week, please see the next step WEEKLY PROGRAMMES. To check a programme or to make a new one, follow these steps:

Press the **PRG** key and the display will show 00:00 intermittently. Press one of the three keys    to allocate SUN, MOON or OFF (frost protection) from 00:00h to 00:30h. If SUN or MOON temperatures are selected the relevant luminous indicator will be lit. If OFF temperature  is selected both luminous indicators will be off.

Press the **+** key to go to the next interval. The display will show **00:30** intermittently and, again, press one of the three keys    to allocate SUN, MOON or OFF (frost protection) from 00:30h to 01:00h or press **+** key directly if the existing temperature level is ok.

Repeat these steps allocating the desired temperatures levels over the 24 hours of the day. Press the **-** key at any time to modify a previous period. By reaching the **23:30** in the display and pressing **+** key, the controller will store the program and will return to the previous mode.

At any time **PRG** key can be used also to store the program and return the previous mode.

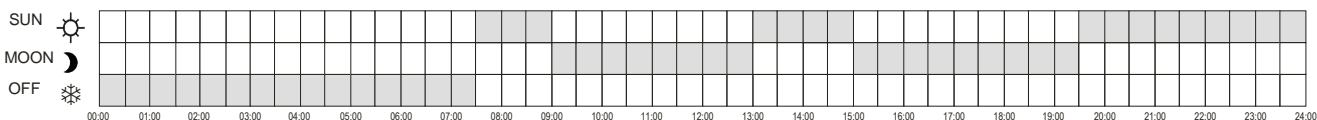

EXAMPLE

Let's see an example of how to introduce a program with the above distribution of temperatures.

OFF from 24:00h to 7:30h in the morning.
The heater will be on only if the temperature drops to 3°C.



















SUN temperature from 7:30h to 9:00h.

MOON temperature from 9:00h to 13:00h.

SUN temperature from 13:00h to 15:00h.



MOON temperature from 15:00h to 19:30h.



SUN temperature from 19:30h to 24:00h.

- | | | |
|------------------------------------------------------------------------------------------------|-----------------------------------------------------------------------------------------|-----|
| 1 - Press PRG | 00:00 | |
| 2 - Press  |  ↖ | Off |
| 3 - Press + key | 00:30 | |
| 4 - Repeat steps 2 and 3 until display shows: | 07:30 | |
| 5 - Press  |  ↖ | On |
| 6 - Press + key | 08:00 | |
| 7 - Press  |  ↖ | |
| 8 - Press + key | 08:30 | |
| 9 - Press  |  ↖ | |
| 10 - Press + key | 09:00 | |
| 11 - Press  |  ↖ | |
| 12 - Press + key | 09:30 | |
| 13 - Repeat steps 11 and 12 until display shows: | 13:00 | |
| 14 - Press  |  ↖ | |
| 15 - Press + key | 13:30 | |
| 16 - Repeat steps 14 and 15 until display shows: | 15:00 | |
| 17 - Press  |  ↖ | |
| 18 - Press + key | 15:30 | |
| 19 - Repeat steps 17 and 18 until display shows: | 19:30 | |
| 20 - Press  |  ↖ | |
| 21 - Press + key | 20:00 | |
| 22 - Repeat steps 20 and 21 until display shows: | 23:30 | |
| 23 - Press  |  ↖ | |
| 24 - Press + key | GRAB | |

WEEKLY PROGRAMMES



It is possible to allocate different programs to different days of the week. To do this, the controller has to be upgrade from 24hr mode (factory default) to 24hr/7days mode as follows:

Move the selector to **0** position, the display will be Off. Press the  key and at the same time turn the selector to **P** position maintaining the  key at least five seconds. The display will show **P-SE** which means that weekly mode has been set.

SETTING THE DAY: Press the  key more than two seconds and the display will show the number of the day. Set the correct number, if required, by pressing **+** or **-** keys. Press the  key and the display will show now the time. Press again the  key and new values will be stored.



To check a programme or to make a new one press **PRG** key: The display will show **dia1**. Press again **PRG** key and the display will show **00:00** intermittently. Follow now the steps from DAILY PROGRAMMES section until the display shows again **dia1**. Repeat this process with the 7 days of the week. When the display shows **dia7** the weekly program will be stored by pressing **+** key.

If the display shows **dia1 then, pressing **+** key more than three seconds will copy the day 1 program to day 2 and so on.**

It is possible to allocate any of the three temperature levels to all the intervals of any day maintaining the relevant    key until an audible signal is heard.

To turn back a controller from 24hr/7days to a single 24hr press **PRG** key more than six seconds. This will restore the factory default settings.

KEYBOARD LOCK

Press the  key more than six seconds and the keyboard will be locked. The display will show **[- -]** and the controller will keep on working internally. To unlock the keyboard, press again the  key more than six seconds.

SUN MANUAL OVERRIDE

In programming mode, the heater will maintain the sun temperature set point and will ignore the pre-set program until the next change in programming temperature level.

Maintain the SUN Key pressed for 4 seconds in programming mode to set the Sun Manual Override. Both luminous indicators SUN and MOON will be lit. This function could be useful when SUN temperature is required and we do not want to modify the program.

By pressing the SUN key for 4 seconds with Sun Manual Override activated, the function will be removed and the heater will follow the programme again.

4.- ADVANCED FUNCTIONS

OPEN WINDOW DETECTION

With open window detection activated, the heating element will be disconnected automatically when a sharp decrease in temperature in the room is detected avoiding energy wastage. After this period of time, the radiator returns to the prior operation mode.

When Open Window Detection is working, the word Open will be displayed alternating with the status of the current mode.

Note: To activate the open window detection please refer to ADVANCED FUNCTION ACTIVATION section.

ADAPTIVE START CONTROL



RXE Plus electronic control analyses the heating requirements of the room where the radiator is installed using this information to turn on the heating element in advance in order to reach the set point temperature at the desired time.

When Adaptive Start Control is working, the word AdAP will be displayed alternating with the status of the current mode.

Note: To activate the adaptive start control please refer to ADVANCED FUNCTION ACTIVATION section.

ADVANCED FUNCTION ACTIVATION

Advanced functions Open Windows Detection and Adaptive Start Control are disabled by default. To enable / disable these functions, the following steps must be followed:

Move the selector to **0** position, the display will be Off. Press the  key and at the same time turn the selector to **P** position maintaining the  key at least five seconds.

The display will show **OPEN** alternating with the status of the function (On or OFF). Use the navigation keys **+** or **-** to enable / disable Open Windows Detection function.

Confirm the new value for the function by pressing the **PRG** key. The next function (AdAP) is shown alternating with its status (On or OFF). Use the navigation keys **+** or **-** to enable / disable Adaptive Start Control function. Confirm the new value for the function by pressing the **PRG** key.

5.- UNIT RESET

The heater reset establishes the factory configuration of the heater removing the programming, establishing the daily programming and disabling the advanced functions. To reset the unit, hold the **PRG** key for 4 seconds, the display will show **InIC** to indicate the heater has been reset.

6.- CLEANING AND MAINTENANCE

The radiators do not precise any special maintenance providing thermal comfort during large periods. Clean dust with a dry, soft cloth only when the unit is disconnected and cold.

Do not use solvents or abrasive products for cleaning.

This thermal radiator has been manufactured under an assured quality system using environment friendly processes.

Please take the heaters to a clean point once their useful life is finished, in order to recycle their materials in the right way.

7.- TROUBLESHOOTING

The thermal radiator does not heat.	Check the heater or the air inlets are not covered. If the display shows the time, press the ☀ key to switch on the heater. Check that the DAY or NIGHT temperatures are right.
The room does not reach the required temperature.	Check the selected temperature is in accordance with the desired temperature. Maybe the room needs more heating power.
DAY and NIGHT luminous indicators are lit at the same time	Continuous mode has been selected. If the knob is in the "I" Position, turn it to the "P" position to return to the program mode if required. If the knob is in the "P" Position, hold the Sun key for 4 seconds to return to the programming.
The display shows "Err1" or "Err2"	Contact the after sales service.
Only daily programmes	The controller is in single 24hr mode (factory default). See WEEKLY PROGRAMMES section to switch to 24hr/7days mode.
The keyboard does not respond.	If the display shows  , the keyboard is locked. To unlock it, press the ☀ key more than six seconds.

8.- SPECIFICATIONS

Models	RX4E Plus	RX6E Plus	RX8E Plus	RX10E Plus	RX12E Plus	RX14E Plus
Elements	4	6	8	10	12	14
Length (cm)	41.5	57.5	73.5	89.5	105.5	121.5
Width (cm)	10 cm plus 2 cm clearance					
Height (cm)	58					
Weight (kg)	9,5	13.5	17.5	21.5	25.5	29.5
Voltage	220 – 240 V~					
Isolation	Class I					
Power (W)	500	750	1000	1250	1500	2000

9.- MAIN COMPONENTS LIST

Right side plastic case	ref. 30100900	2x250 W Heating Element	ref. 30201825
Left side plastic case	ref. 30100910	2x375 W Heating Element	ref. 30201830
Main PCB	ref. 30100084	2x500 W Heating Element	ref. 30201835
Rotary switch	ref. 30100015	2x625 W Heating Element	ref. 30201840
Keyboard	ref. 30100968	2x750 W Heating Element	ref. 30201845
85°C thermal limiter	ref. 30100040	2x1000 W Heating Element	ref. 30201855

10.- WIRING

R heating element
Ts safety cut out
C three way selector

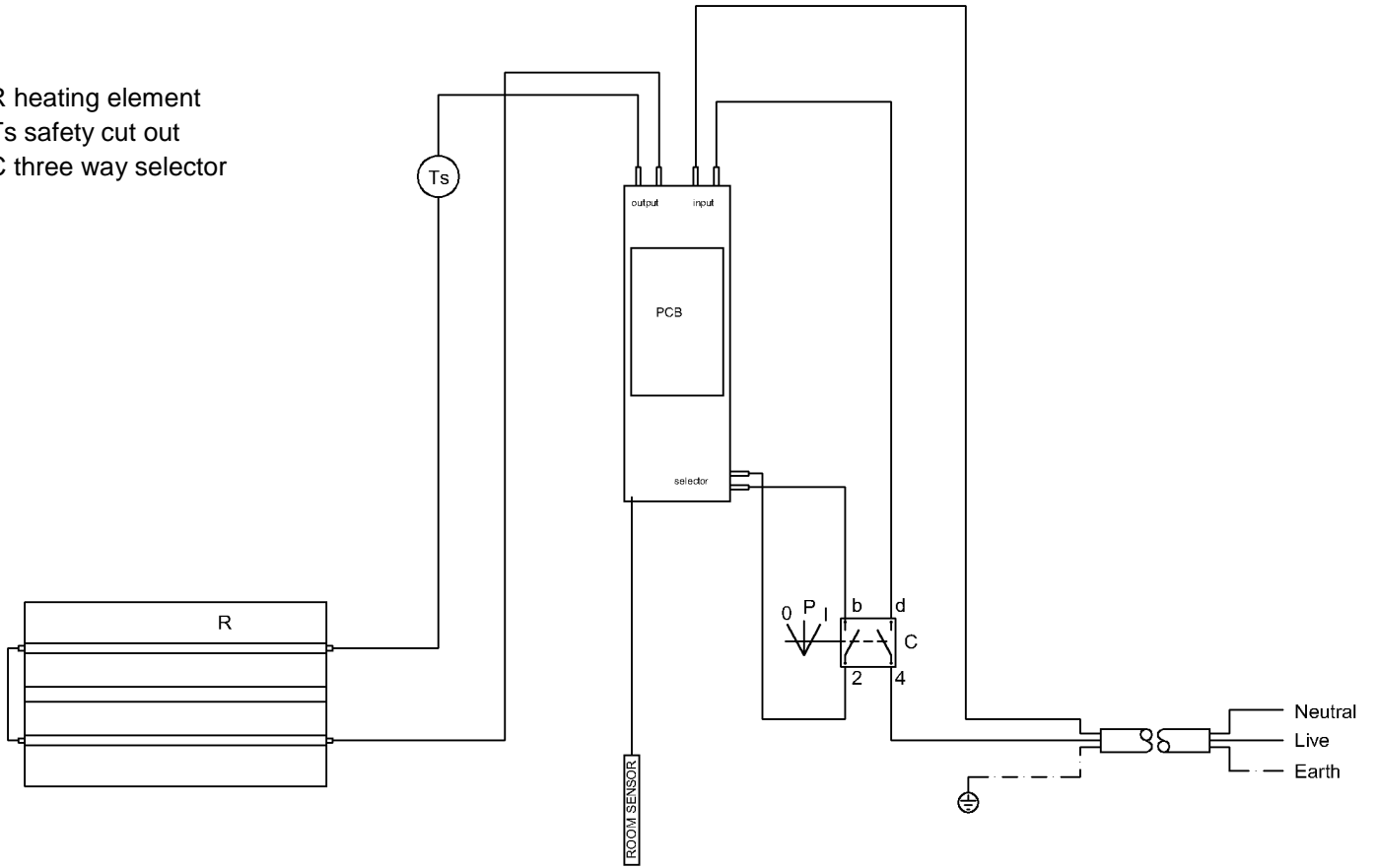

II.- PRODUCT FICHE

ErP

MODEL(S): **GABARRON RX4E Plus, RX6E Plus, RX8E Plus, RX10E Plus, RX12E Plus, RX14E Plus**

Item	Symbol	Value						Unit
		RX4E Plus	RX6E Plus	RX8E Plus	RX10E Plus	RX12E Plus	RX14E Plus	
Heat Output								
Nominal heat output	P_{nom}	500	750	1000	1250	1500	2000	W
Minimum heat output	P_{min}	N.A.	N.A.	N.A.	N.A.	N.A.	N.A.	W
Maximum continuous heat output	$P_{max,c}$	500	750	1000	1250	1500	2000	W
Auxiliary electricity consumption								
In standby mode	e_{sb}	0,68	0,68	0,68	0,68	0,68	0,68	W

Item	Value. All models
Type of heat output / room temperature control	
Electronic room temperature control plus week timer	Yes
Other control options	
Room temperature control, with open window detection	Yes
With distance control option	No
With adaptive start control	Yes

Contact details	ELNUR, S.A. Travesía de Villa Esther, 11 28110 – Algete (Madrid), Spain
------------------------	-------------------------------------------------------------------------------

Commission Regulation (UE) 2015/1188 of 28 April 2015. Ecodesign requirements for electric fixed local space heater.



EN: WARNING: In order to avoid overheating do not cover the heater.



The symbol on the product or in its packaging indicates that this product may not be treated as household waste. Instead it shall be handed over to the applicable collection point for the recycling of electrical and electronic equipment. By ensuring this product is disposed of correctly, you will help prevent potential negative consequences for the environment and human health, which could otherwise be caused by inappropriate waste handling of this product. For more detailed information about recycling of this product, please contact your local city office, your household waste disposal service or the shop where you purchased the product. These instructions are only valid in the EU member states.



Supplier:

ELNUR UK Ltd.
Unit I, Brown Street North
Leigh, Lancashire. WN7 1 BU
Telephone +44(0)1942 670119
www.elnur.co.uk
info@elnur.co.uk

Manufactured by:

ELNUR S.A.
Travesía de Villa Esther, 11
28110 Algete - Madrid
Telephone +34 91 628 1440



As a part of the policy of continuous product improvement, Elnur s.a. reserves the right to alter specifications without notice.