

## AGILA IO

COMPACT GENTLE HEAT RADIATOR WITH  
POSSIBILITY OF REMOTE PILOTING



All electrical appliances produced for the Company are guaranteed for one year against faulty material or workmanship. This applies only if the appliance has been used for purposes in accordance with the instructions provided and has not been connected to an unsuitable electricity supply, or subject to misuse, neglect, damage or modified or repaired by any person not authorised by the Company. This guarantee is offered to you as an extra benefit and does not affect your legal rights. The correct electricity supply voltage is shown on the rating label attached to the appliance. Reasonable care has been taken to ensure that this guide is accurate at the time of printing. In the interest of progress the Company reserve the right to vary specifications from time to time without notice.

**Contents**  
(RCH-BD1C / RCV-BD1C)

<b>Warning</b>	<b>2</b>
<b>Declaration of Conformity - Directive RED 2014/53/EU</b>	<b>3</b>
<b>Installation</b>	<b>4</b>
Preparing for installation of the appliance	4
Installing the appliance	5
Connecting the appliance	7
Mounting the appliance	7
Maintenance	9
<b>Operation</b>	<b>10</b>
Operating principle	10
The switch	10
Turning the appliance on / off	10
Locking commands	10
Connectivity	10
Description of the modes	13
Adjusting the temperature	15
Using the internal programming	16
Using the external programming	17
Open Window menu	17
Presence menu	18
Consumption indicator	19
<b>The BASIC mode menu</b>	<b>20</b>
<b>The PROG mode menu</b>	<b>21</b>
<b>The AUTO mode menu</b>	<b>22</b>
<b>The EXPERT menu</b>	<b>23</b>
<b>Restrictions</b>	<b>25</b>
<b>Power cut-off</b>	<b>25</b>
<b>Troubleshooting</b>	<b>26</b>

Thank you for choosing this appliance and for the confidence you have thus placed in us. Your recently acquired radiator has undergone numerous tests and inspections to ensure the best quality and to thus provide you with complete satisfaction.

Please read your radiator's instructions and familiarise yourself with the operating guidelines in order to enhance your well-being.

Do not discard the instructions, even after the radiator has been installed.

## Warning

---



- Caution very hot surface.

**CAUTION:**

**Some parts of this product can become very hot and cause burns. Particular attention is required when children and dependent individuals are present.**

Children under 3 must be kept away from this appliance, unless they are under constant supervision.

Children between the ages of 3 and 8 must only turn the appliance on or off provided that the appliance has been positioned or installed in a normal intended position and provided that the children are supervised or have been instructed with respect to the safe use of the appliance and that they fully understand the potential dangers. Children between the ages of 3 and 8 must not connect, adjust or clean the appliance or perform any product maintenance.

This appliance can be used by children who are at least 8 years old and by persons with limited physical, sensory or mental abilities or without any experience or knowledge of the appliance if they are properly supervised or if they have been given instructions with respect to the safe use of the appliance and if the potential risks have been understood. Children must not play with the appliance. Cleaning and maintenance of the appliance by the user must not be performed by children without supervision.



To prevent overheating and for safety reasons, do not cover the heating appliance.

The operating instructions for this appliance are available from our website or by contacting the after-sales department.



: Appliances with this symbol must not be disposed of in household waste but must be collected separately and recycled. The collection and recycling of end-of-life products must be carried out according to local provisions and orders.

**DECLARATION OF CONFORMITY  
DIRECTIVE RED 2014/53/EU**

Thermor Pacific hereby declares that the equipment referred to hereafter is compliant with the essential requirements of directive RED 2014/53/EU.

The EU declaration of conformity completed for this equipment is available on request from our after-sales department (the address and telephone number are provided at the end of the manual).

**Designation:** Radiator with BDIC radio card

**Models:** refer to the model reference in the manual's header

**Features:**

**Radio frequency:** 868 MHz Transceiver

**Class 2 radio equipment:** can be marketed and commissioned without any restrictions.

Radio range: from 100 to 300 metres in free-field conditions, varying according to the auxiliary equipment (the range can be altered depending on the installation conditions and the electromagnetic environment).

**Conformity with radio standards and electromagnetic compatibility has been verified by notified body 0081: LCIE France, Fontenay aux Roses.**

## PREPARING FOR INSTALLATION OF THE APPLIANCE

### I- Installation of the appliance

Your appliance is delivered with its own wall bracket. However, the choice of screws and of wall plugs depends on the nature of your wall and you are responsible for ensuring that you use screws and wall plugs that are adapted to the weight of the appliance.

Once the cardboard box cover has been removed, you can remove the wall bracket, which you can then use as a hole drilling template.

To facilitate connection, this appliance has been designed so that it stands upright throughout the connection period. For a Vertical appliance, ensure that the appliance is placed in its wedge against the wall until it is placed on the wall bracket.

### 2 - Installation guidelines

This appliance has been designed to be installed in a residential room.

The installation must be carried out implementing best practices and in accordance with the current standards in the country of installation (NFC 15100 for France).

Observe the minimum distances from furniture when locating the appliance (refer to the diagram).

Do not install shelving above vertical appliances.

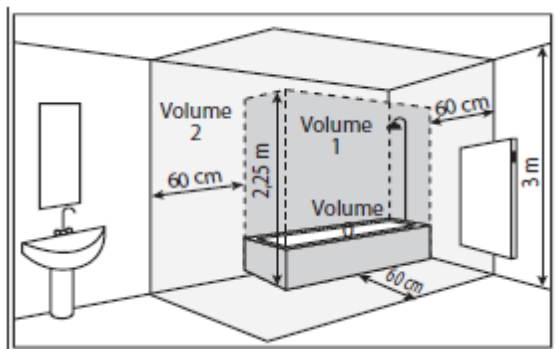
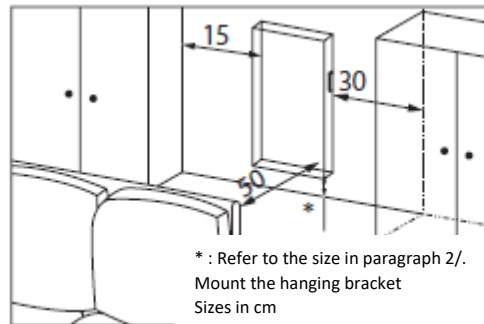
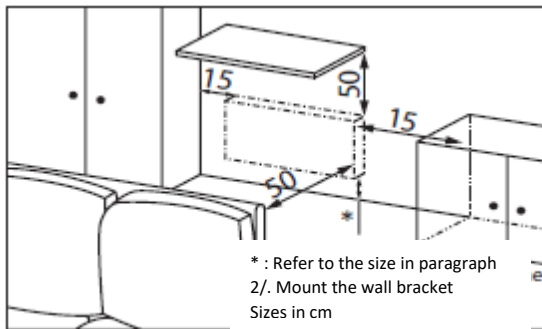

If you have a foam-mounted wall covering then a wedge having the same thickness as the foam must be placed under the appliance's bracket so that an open space is maintained behind the appliance to prevent any interference with its adjustment.

**Do not install the appliance:**

- In an air current that is likely to interfere with its adjustment (under a Centralised Mechanical Ventilation system, etc.).
- Under a fixed electric socket.
- In bathroom areas shown as 'Volume I' in the above diagram.

Appliances used in bathrooms must be installed so that the switches and other devices for controlling the appliance cannot be touched by an individual in the bath or the shower.

	Installing an appliance at altitude increases the air outlet temperature (by approximately 10°C per 1,000 m of elevation).
---	--

Installing the appliances above an altitude of 1,000 m is not recommended (risk of faulty operation). Installing a vertical appliance horizontally, and vice versa, is prohibited. Using the appliance in a mobile configuration, on feet or on rollers, is prohibited.

**INSTALLING THE APPLIANCE**

**1 - Unlocking the hanging bracket from the Horizontal appliance**

We recommend leaving the appliance in its protective wedges and laying it flat, face downwards.

- Use a screwdriver to lift the tab, without deforming the tab.
- Push the bracket downwards to disengage the upper hooks.
- Pivot the hanging bracket.
- Then remove the bracket.

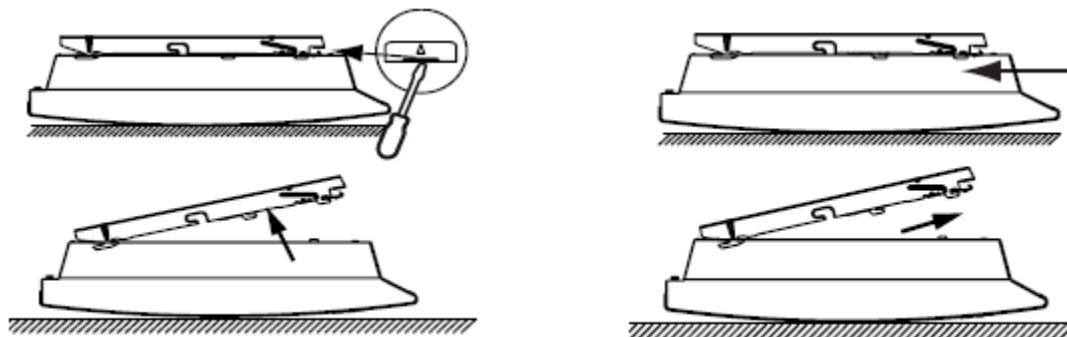

**2- Mounting the hanging bracket**

Horizontal Model

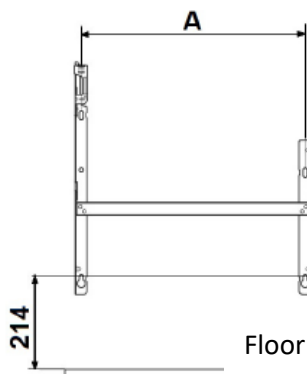

Power	A
500 W	120.8
750 W	120.8
1000 W	194.8
1250 W	268.8
1500 W	342.8
2000 W	490.8

### Vertical Model

- Procure wall plugs and screws that are adapted to your type of wall according to the weight of the appliance (*the screws and wall plugs are not supplied*).
- Use the mounting template.
- Find the middle of the radiator using the dashed line.
- Find the 4 drilling points for mounting the radiator and mark them with a pencil.

Power	A	B
1500 W	1082	456
2000 W	1230	456

- Drill the 4 mounting holes for the radiator and insert the wall plugs.
- Insert the screws into the wall plugs (*leave the screws protruding by 6 mm maximum*).

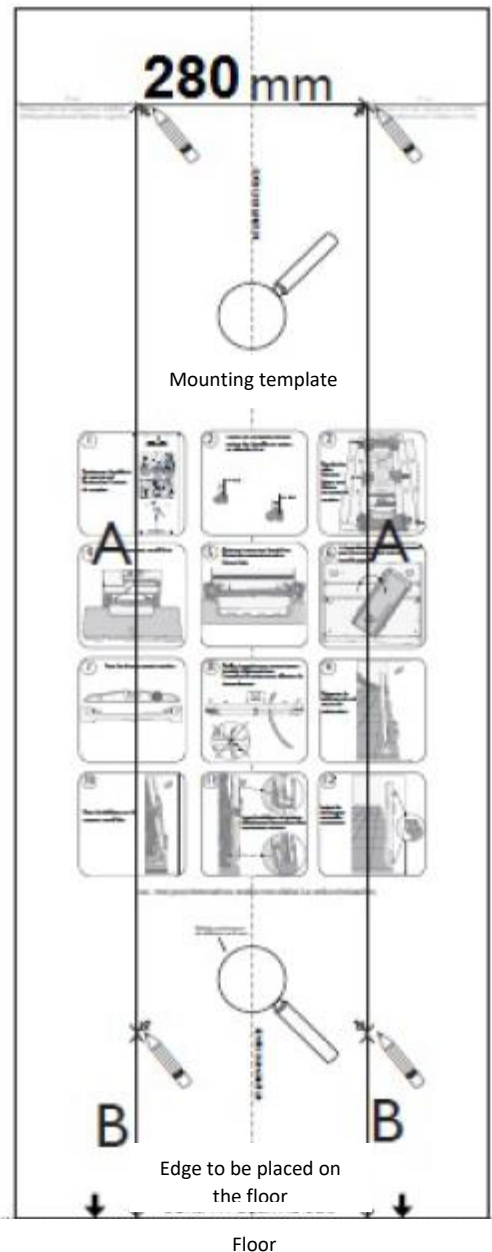
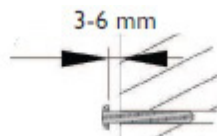

- Position the bracket by passing the screw heads through the slots.
- Before commencing screwing, align the lower wall bracket marks with the 2 screws.
- Ensure that the brackets are level.
- Screw in the brackets.

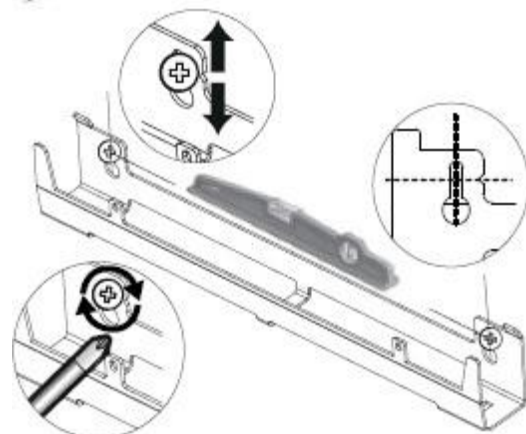

## CONNECTING THE APPLIANCE



### Vertical Model

If the electrical junction box is located above the lower wall bracket, then connect by passing the power supply cable through the bracket. This avoids pinching the cable.

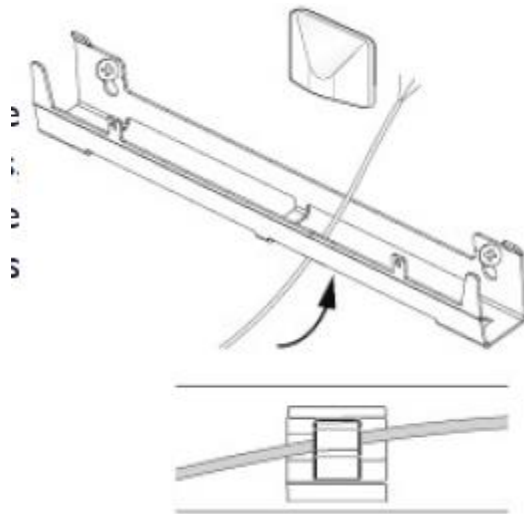

### Connection guidelines

- The appliance must be supplied with 230 V 50 Hz.
- The radiator power supply must be directly connected to the network downstream of the omnipolar cut-off device in accordance with the installation guidelines. A 3-wire cable (Brown = Phase, Blue = Neutral, Black = Pilot wire) is used to connect to the supply circuit through a junction box.
- In humid rooms, such as kitchens and bathrooms, the junction box must be installed at least 25 cm from the ground. The installation must be equipped with a circuit-breaker type protective device, with a 30 mA differential.
- **Connection to ground is prohibited. Do not connect the pilot wire (black) to ground.**
- If the power supply cable is damaged, it must be replaced by the manufacturer, their after-sales department or by a similarly qualified individual for safety reasons.
- If the control or controlled device is protected by a 30 mA differential (for example: in the bathroom), the power supply for the pilot wire on this differential needs to be protected.

## MOUNTING THE APPLIANCE

### Horizontal Model

- Place the appliance on the S bracket as per the diagram.
- Move the appliance towards the bracket, then lift the appliance (arrows 1 and 2).
- Introduce the mounting brackets into the holes on the appliance, then lower the appliance (arrow 3).
- Lock by rotating the 2 V-locks by a half turn, your appliance is now mounted.



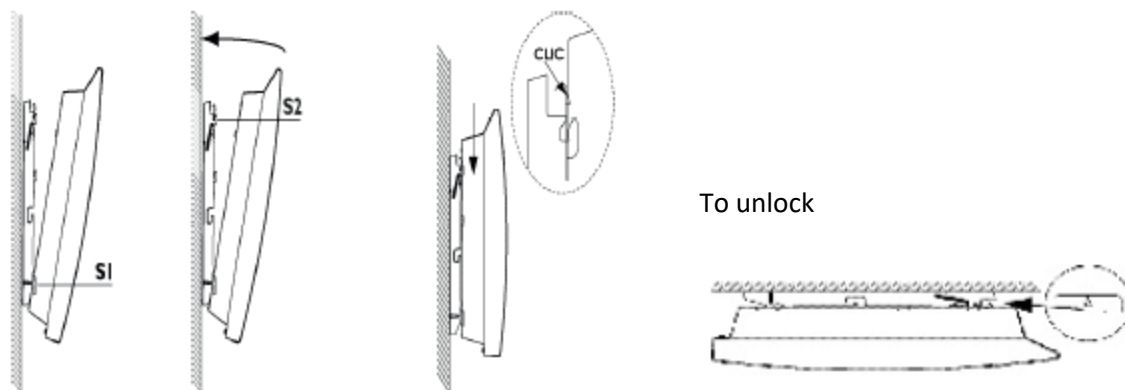

### **Vertical Model**

- Place the radiator on the ground in front of the wall brackets.
- Lift the radiator in order to place the lower hooks of the radiator on the lower wall bracket.
- Move the top of the radiator towards the upper wall bracket until they make contact.

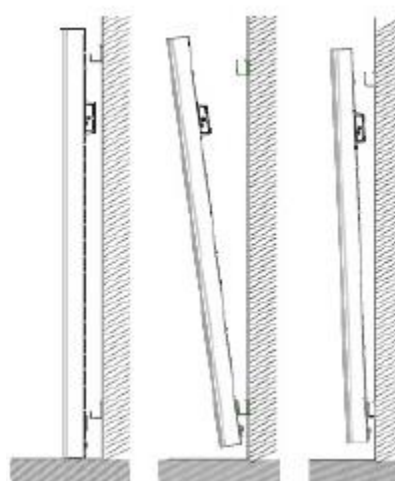

- Gently lift the radiator away from the wall.
- Move the top of the radiator towards the wall.
- Gently lower the radiator.
- Place the upper hooks onto the upper wall bracket and the lower hooks onto the lower wall bracket.
- Lock the radiator onto the brackets by clipping-in the 4 plastic covers to ensure that the appliance is properly mounted.

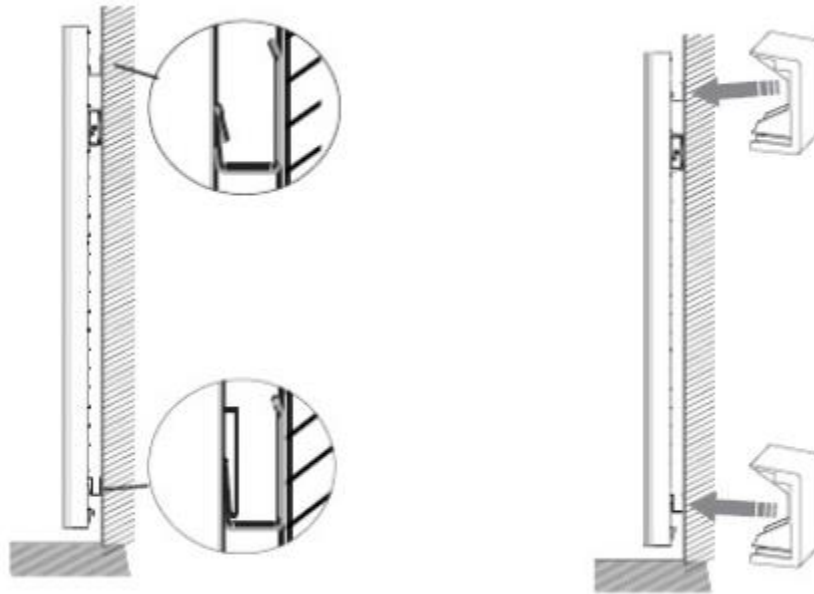

## MAINTENANCE

Before performing any maintenance work, turn off your appliance by turning the On/Off switch to the 0 position.

In order to maintain the performance levels of your radiator, dust needs to be removed from the lower and upper grills of the appliance approximately two times per year using a vacuum cleaner or a brush. The appliance can be cleaned using a damp cloth; never use abrasive products and solvents. In a polluted environment, dirt can appear on the appliance's grill. This phenomenon is associated with the poor quality of the ambient air. In this case, we recommend checking that the room is properly ventilated (ventilation, air inlet, etc.). This dirt does not constitute grounds for warranty replacement of the appliance.

## Operation

### OPERATING PRINCIPLE

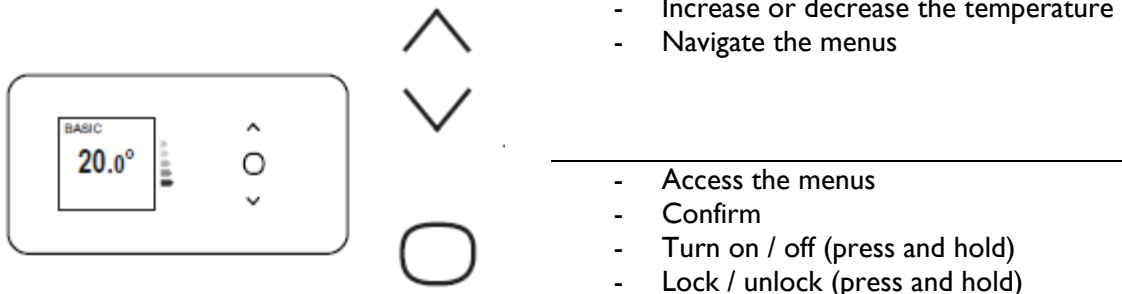

### THE SWITCH

An On/Off switch is located behind the appliance's casing.

Only use the switch for an extended shut-down period (outside the heating period).

Set the switch (located behind the appliance) to I to turn on the appliance. When the appliance is turned off, the day and the time may need to be reset.

### TURNING THE APPLIANCE ON / OFF

On initial start-up, select the language, then enter the date and time.





On initial power-up:

- AUTO mode is selected;
- the setpoint temperature is set to 19°C.

To turn off the appliance, press and hold .



Confirm "Turn off" by pressing .

To turn on the appliance, press and hold .

You can also stop the appliance through the main menu by pressing , this screen  will appear, then press  until Turn off  appears and confirm using .

### LOCKING COMMANDS

To prevent operation by children, you can lock your appliance's commands by pressing and holding .

Select "Lock"  and confirm using .

Perform the same procedure for unlocking the commands, but select "Unlock" .

### CONNECTIVITY

Before performing any action, illuminate the screen by pressing any key.

You can access the connectivity parameters in any mode.

Our units are compatible with **iO-homecontrol®**.

This highly secure wireless radio communication technology is integrated in a wide range of household equipment proposed by home specialist partner brands. With our heating appliances that integrate **iO-homecontrol®** you can:

- **Pair** several compatible appliances **iO** in the same room (up to a maximum of 5 appliances).
- **Connect** your appliances to the Cozytouch app to remotely control the appliance (from the app).

### Accessing Online functions:

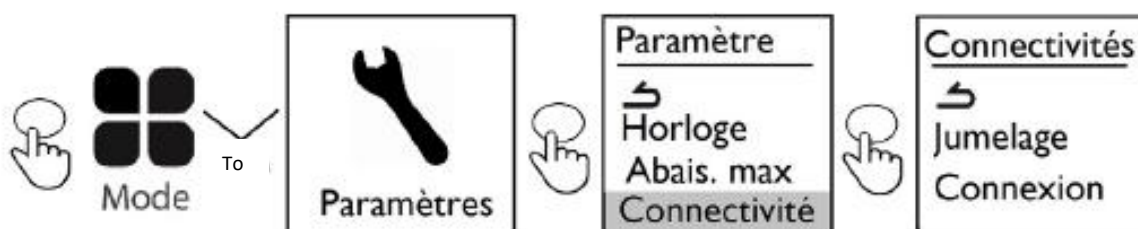

**iO** appliances that are located in the same room can be paired so that they can communicate and share information.

For example, when several appliances are paired, a change in the setpoint temperature or in a mode on one appliance is immediately fed back to all the other appliances.

Similarly, if one of the appliances in the room detects your presence, it will send this information to the other appliances.

### Pairing

For example: pairing 3 appliances in the same room:

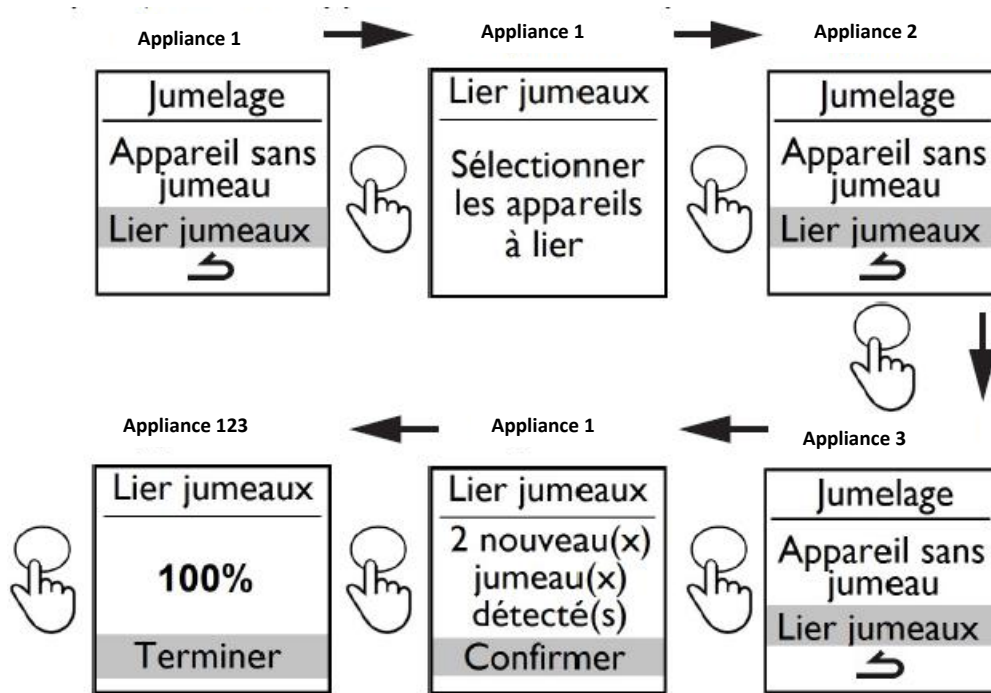

or wait a few minutes to return to the initial screen.

### Display the paired appliances

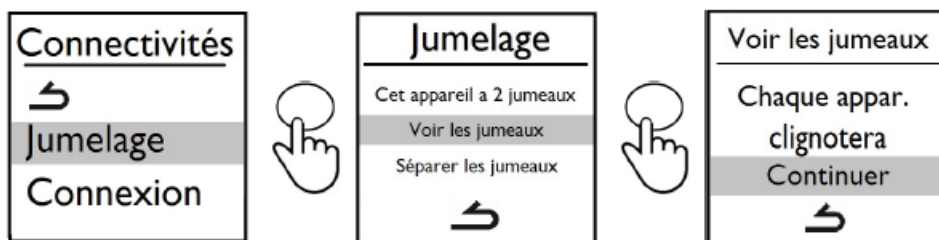

### Delete pairing

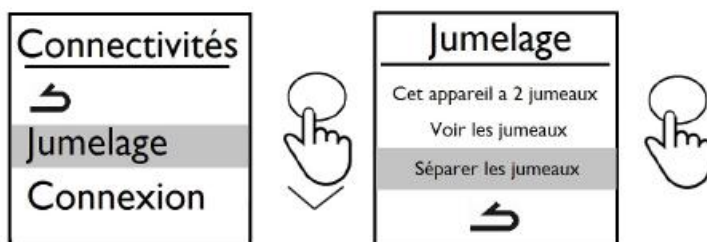

### Add a pair

The existing pairing must be deleted (refer to "Delete pairing") and the operation must be restarted to pair all the appliances.

### Connection

This appliance is compatible with our Cozytouch product (all the relevant information is available on our website) and with units using the **iO-homecontrol®** protocol.

Required accessories:

- iOS and Android compatible Cozytouch App. Available as a free download from the App Store or from the Google Store.



Cozytouch Bridge. Sold by our brand distributors or on our website.



Internet access unit.



This installation allows you to remotely control, program and check your  appliance(s) using a smartphone or a tablet.

For example, you can change the setpoint temperature or the operating mode, manage your periods of absence by indicating your return date or view the consumption of your appliances.

You can connect to the app, to an appliance or to a set of appliances that you have paired.



**Perform all the connection or control operations from the app** (follow the instructions displayed on your smartphone or on your tablet).

### Connect your appliances

Follow the instructions provided in the app.

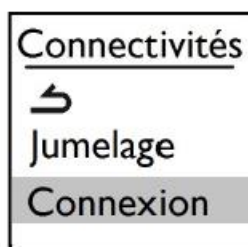
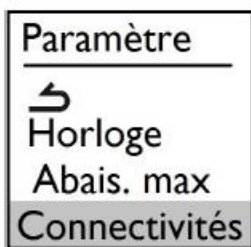

If the appliances are already paired, then perform this operation on one appliance only.



## DESCRIPTION OF THE MODES

**3 operating modes are provided.**

Before performing any action, illuminate the screen by pressing any key. Select the most suitable mode for your requirements.

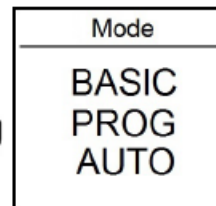
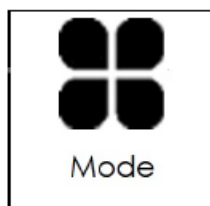
Press



Select the desired mode using  or  and confirm 

### BASIC

The appliance continuously adheres to the adjusted setpoint temperature.  
All the smart functions are deactivated.

## **PROG**

- Either the appliance adheres to the internal program defined for each day of the week. The following periods are defined when the appliance is turned on:  
Monday to Friday, comfort from 05:00 hrs to 09:00 hrs and from 17:00 hrs to 23:00 hrs.  
Saturday and Sunday, comfort from 05:00 hrs to 23:00 hrs.

You can change these periods and define 3 Comfort temperature periods per day. Throughout these Comfort periods, the temperature setpoint is adjusted using  $\wedge$  or  $\vee$ . Outside the Comfort periods, lowering the temperature is adjusted in the "Lower ECO T°" Prog mode (refer to "The PROG mode menu" chapter).

- Or the appliance adheres to instructions from the external programming system for your installation through a pilot wire link or a radio link.

To define the programming source:

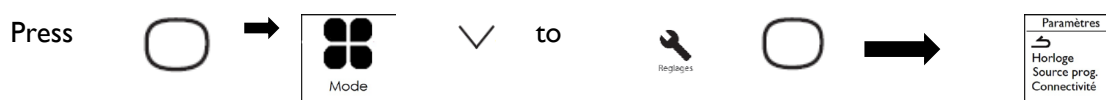

Select "Prog. Source" and select "Internal Prog." or "Ext. Control" using  $\vee$ .

## **Accessible functions**

- Detection function

By default, the presence detection function is inactive and the open window function is active (refer to the "Detection Functions" chapter).

Activating the presence detection function in Prog Mode allows any unforeseen presence to be detected automatically.

For example: for Monday you programmed a temperature period from 17:00 hrs to 23:00 hrs. You return at 15:00 hrs. The appliance detects your presence and automatically switches to the Comfort temperature period.

- One-off bypassing of the programming.

Presence detection function inactive.

Allows any unforeseen presence to be managed.

For example: for Monday you programmed a Comfort temperature period from 17:00 hrs to 23:00 hrs. You return at 15:00 hrs and the appliance displays an Eco temperature.

You can manually increase the temperature.

One-off bypassing of the programming is active up until the next Comfort temperature period that is defined in the program. The appliance then reverts to its normal operation.

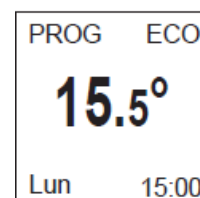

## Auto

This mode allows smart control to be activated. You adjust the desired temperature when you are present in the room and the appliance optimises your comfort whilst implementing savings.

### **The appliance:**

- records your weekly lifestyle and any changes to your lifestyle in order to implement its own programming;
- anticipates heating so that the room is at the correct temperature upon your return;
- detects any unforeseen periods of presence and absence in order to automatically adjust the temperature;
- detects any opening and closing of windows in order to lower the temperature to 7°C when you air the room.

### **Accessible functions:**

- Presence  : always active

- Open window  : active by default, but can be deactivated

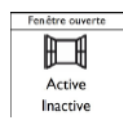

- Displaying information  in AUTO mode:

Displays periods of presence observed by the appliance for each day of the week, the anticipated heating time and any energy savings over the last 7 days.

Your appliance also notifies you of your consumption and its cost.

- Parameters  :

You can access updating of the date and time and switching to summer/winter time and to the maximum temperature reduction, with three possibilities:

- Comfort/Savings Balance (-3°C);
- Priority on savings (-4°C);
- Priority on comfort (-2°C);

and to connectivity in order to choose to pair your appliances in the same room (a maximum of 5 appliances), as well as to connect them to the Cozytouch app so that they can be remotely controlled (from the app).

## **ADJUSTING THE TEMPERATURE**

To change the setpoint temperature, use  $\wedge$  or  $\vee$ .

Use the consumption indicator to optimise your adjustment. When the consumption indicator is level with the green symbol, your temperature level is below or equal to the recommended temperature.

A period of at least 6 hours needs to elapse for the temperature to stabilise.

### In BASIC mode:

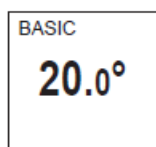



- Increase using  $\wedge$  (max. 28°C).
- Decrease using  $\vee$  (min. 12°C).
- Decrease still further to 7°C (the Frost Protection temperature cannot be changed) using  $\vee$ .

### In PROG mode:

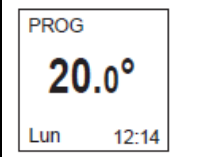

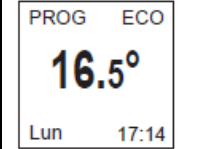
	<p>If the screen displays PROG, you have accessed a programming range in Comfort mode.</p> <ul style="list-style-type: none"> <li>- Increase using <math>\wedge</math> (max. 28°C).</li> <li>- Decrease using <math>\vee</math> (min. 12°C).</li> </ul>
---	---

	<p>If the screen displays PROG ECO, you have accessed a programming range in ECO mode (by default -3.5°C compared to the Comfort temperature).</p>
---	--

	<p>The ECO temperature can be changed, you thus bypass the reduction that you adjusted in the "Lower ECO T°" Prog mode (refer to "The PROG mode menu" chapter).</p>
---	---

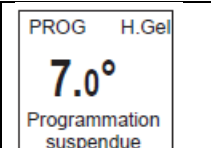
	<p>If you have adjusted a Frost Protection temperature (7°C), programming is suspended. Change this temperature when you want to resume programming.</p>
---	--

In AUTO mode:



	<p>Increase using <math>\wedge</math> (max. 28°C).  Decrease using <math>\vee</math> (min. 12°C).  Decrease still further to 7°C (the Frost Protection temperature cannot be changed) using <math>\vee</math>.</p>
---	--

## USING THE INTERNAL PROGRAMMING

### CHANGING THE PROGRAMS

You can program up to 3 Comfort temperature periods for each day of the week. Outside the Comfort periods, lowering the temperature is adjusted in the "Lower ECO T°" Prog mode (refer to "The PROG mode menu" chapter).

Activate the  Mode   PROG  mode.

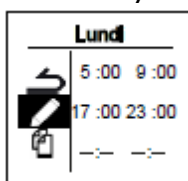

Access the  Mode   Programme    Lundi...Dim  menu.

Select the day using  $\wedge$ . Confirm .



Select . Confirm .

Select the start time for the 1st Comfort period using  $\wedge$  or  $\vee$ .

Confirm . Select the end time using  $\wedge$  or  $\vee$ . Confirm .

Complete the same operation for the 2nd Comfort period and then for the 3rd Comfort period or confirm .

## **COPYING A PROGRAM**

You can copy the program for one day to one (or more) day(s).

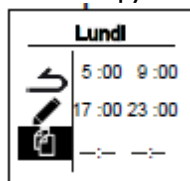

Select . Confirm .

Scroll through the days using  $\wedge$  or  $\vee$ .

Confirm the day you would like to copy to using .

Select "Copy" to confirm copying. Confirm .

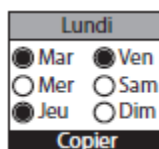

For example: copying the program from Monday to Tuesday, Thursday, Friday.

## **DELETING A COMFORT TEMPERATURE PERIOD**

Select the day using  $\wedge$ . Confirm .

Select . Confirm .

On the start time, select 0:00 using  $\vee$ . Confirm .

On the end time, also select 0:00 using  $\vee$ , then confirm .

## **USING THE EXTERNAL PROGRAMMING**

The appliance adheres to instructions from your installation's external control system through a Pilot Wire link.

Activate the mode.

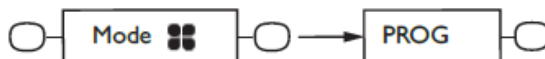

Access the programming source.



Select prog. Source using  $\vee$ . Confirm .

Select ext. Control using  $\vee$ , then confirm .

## **OPEN WINDOW MENU**

The Open Window menu enables detection of temperature variations associated with opening and closing your windows. If you forget to turn off your appliance while a window is open for a long period then this function overcomes this problem and avoids unnecessarily heating your appliance.

The appliance automatically switches to Frost Protection mode (7°C) when it detects an open window and returns to the setpoint temperature when it detects its closure (the detection time varies). The appliance reacts to the opening and closing of windows according to several variables, which particularly include:

- the desired temperature in the room;
- the outside temperature;
- the configuration of the installation.



The use of this function is not recommended in corridors and in rooms located in the vicinity of an

Best location zone.

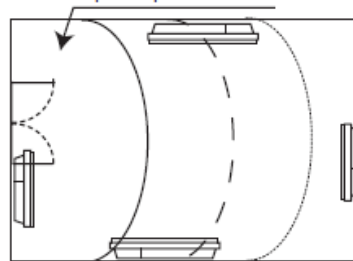

entrance door opening onto the outside.

**The Open Window menu can be accessed from the Prog. Mode and the Auto Mode**

Press , the following screen appears .

Press  to reach the  menu, confirm using .

Select Active or Inactive using  or , then confirm using .

**PRESENCE MENU**

Allows your room to be heated only when someone is present. The appliance will then heat in Comfort mode.

To optimise your appliance's presence detection function, the appliance must be installed to enable optimum detection (for example: do not install the appliance behind a sofa, in a frequently used area, such as a corridor, near a wardrobe, etc.).

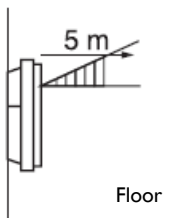
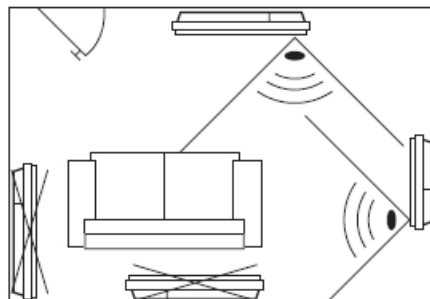

Detection is not possible underneath the sensor.

**Activating/Deactivating the function**



Function always active in AUTO MODE

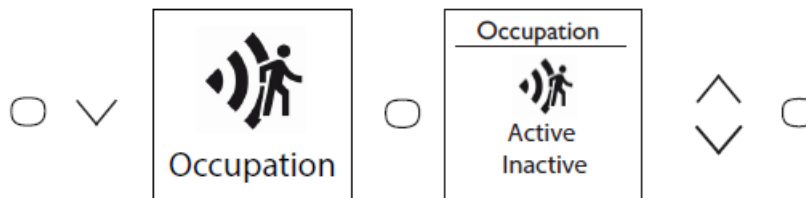

For example: your appliance is set to 19°C in Comfort mode (whether or not it is programmed).

- at 09:00 hrs it detects your presence;
- at 09:30 hrs the operating temperature changes to 18°C;
- at 10:00 hrs the operating temperature changes to 17°C.

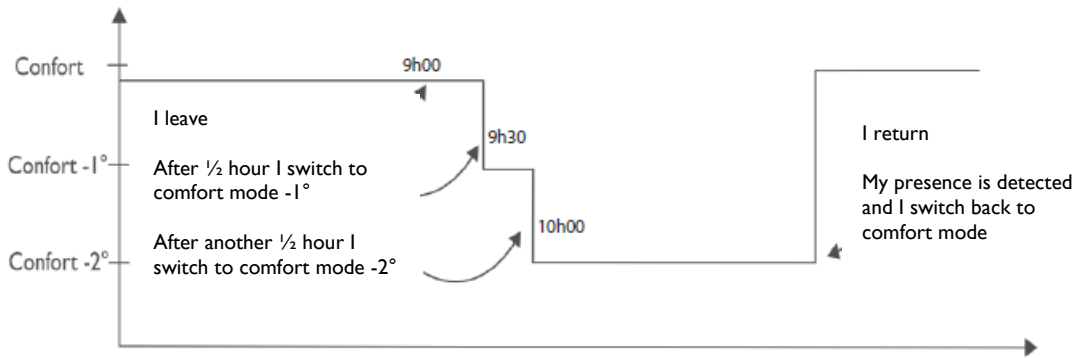

## THE CONSUMPTION INDICATOR

Irrespective of the mode, you can access the power consumption indicator through the information menu **i**. It will display consumption in KWh and the price in Euros.

To access the information menu **i**, press **○**, the Mode screen appears **⊞** ..

Press **✓** to reach the **i**, Information menu, confirm using **○**.

Press **✓**, to access consumption, confirm using **○**.

The cost and the amount of KWh consumed is displayed on the screen.

You can change the KWh price by scrolling to **€** using the **✓** arrow, then confirm using **○**. You can then change the price using **✓** and **^**.

You can also reset the meter by accessing **RESET**, then reset using **✓** and confirm using **○**.

Informations
<b>←</b>
Mode AUTO
Consommation

Consommation
<b>←</b>
RAZ
53 KWh
€
6,36 €

Prix du KWh
<b>↑</b>
0,120 €
<b>↓</b>

Réinitialisation
<b>←</b>
Réinitialisation

## The BASIC mode menu

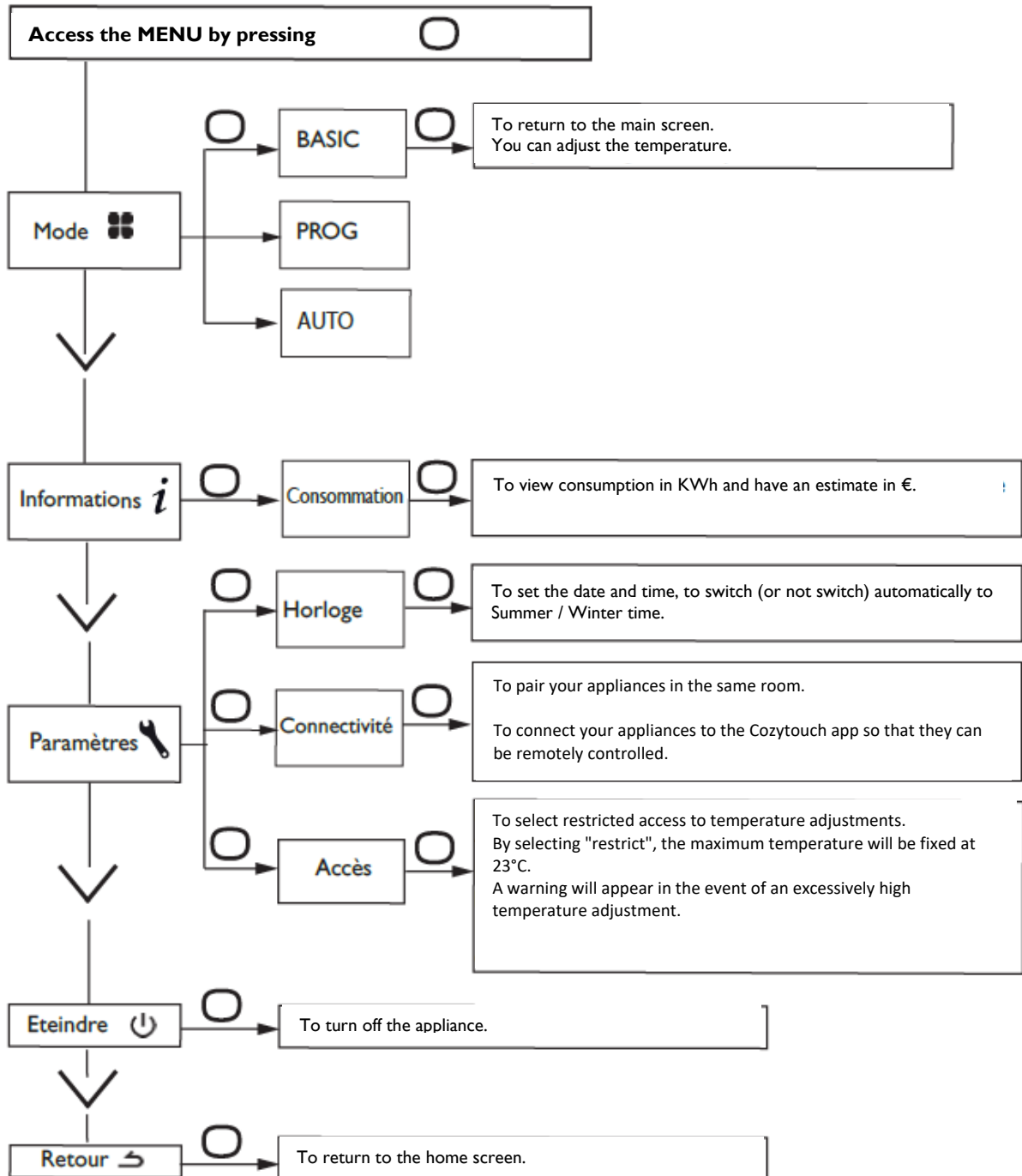

## The PROG mode menu

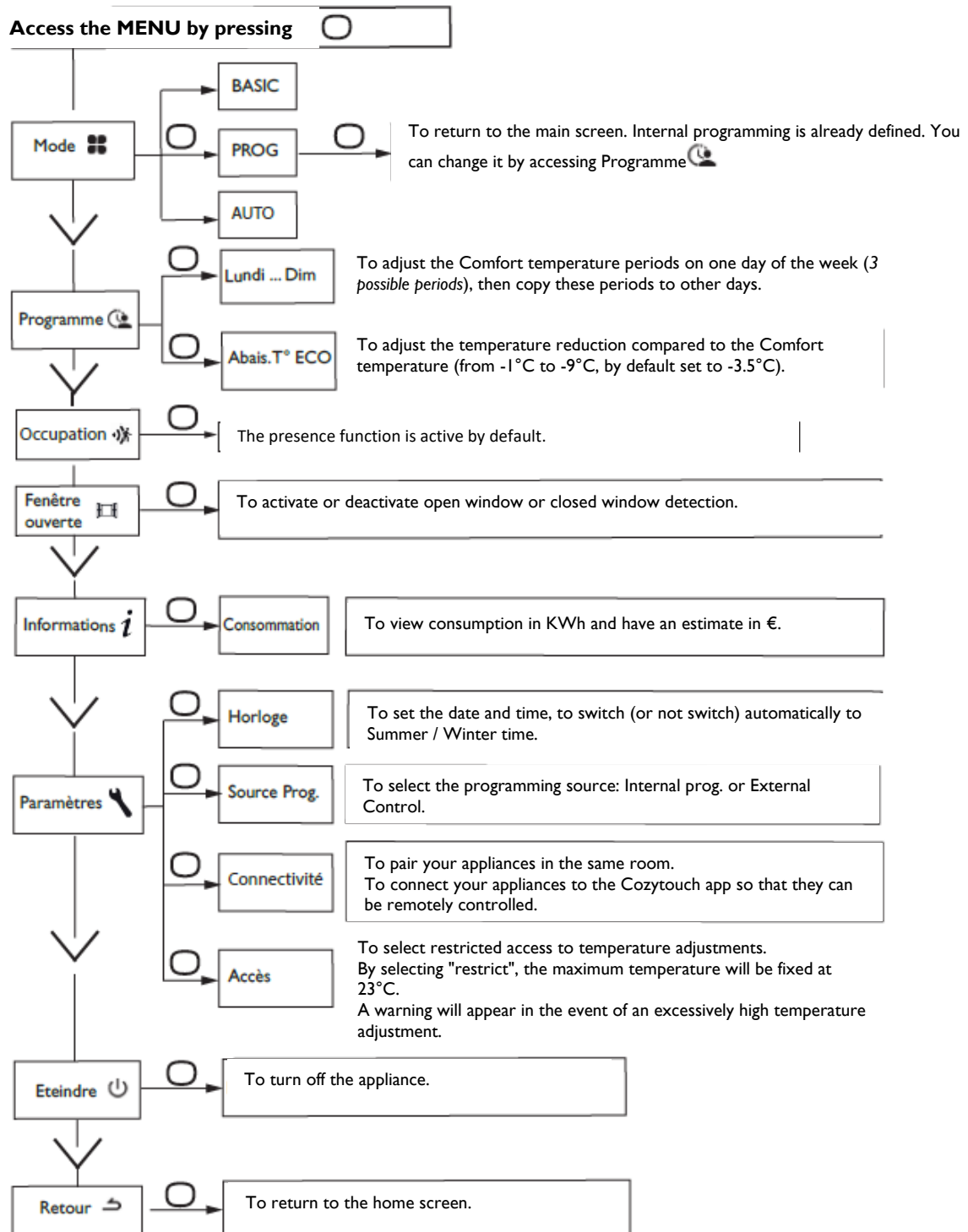

## The AUTO mode menu

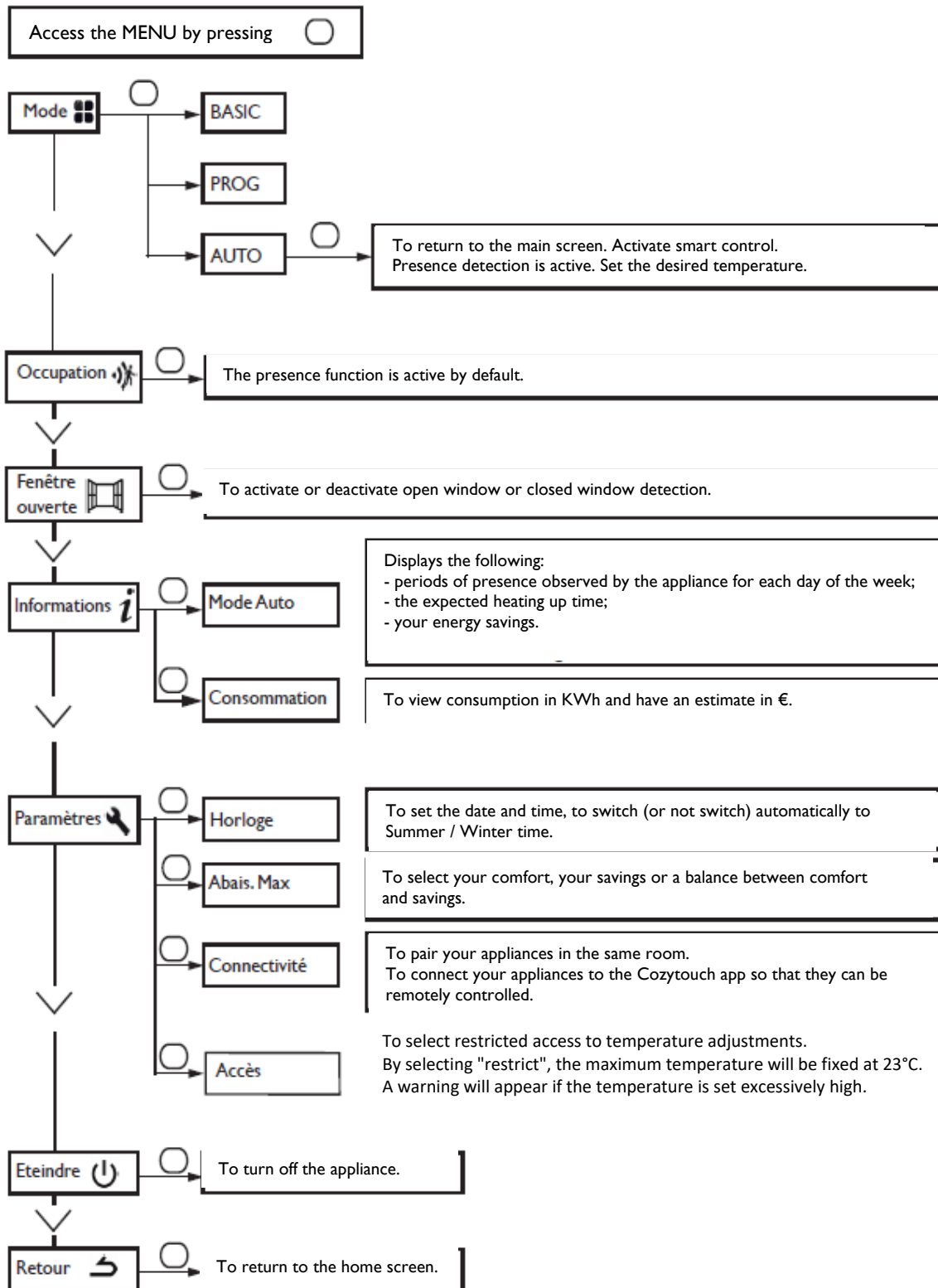

## The EXPERT menu

To access the appliance's advanced functions, press  $\bigcirc$  and  $\wedge$  together for more than 3 seconds.

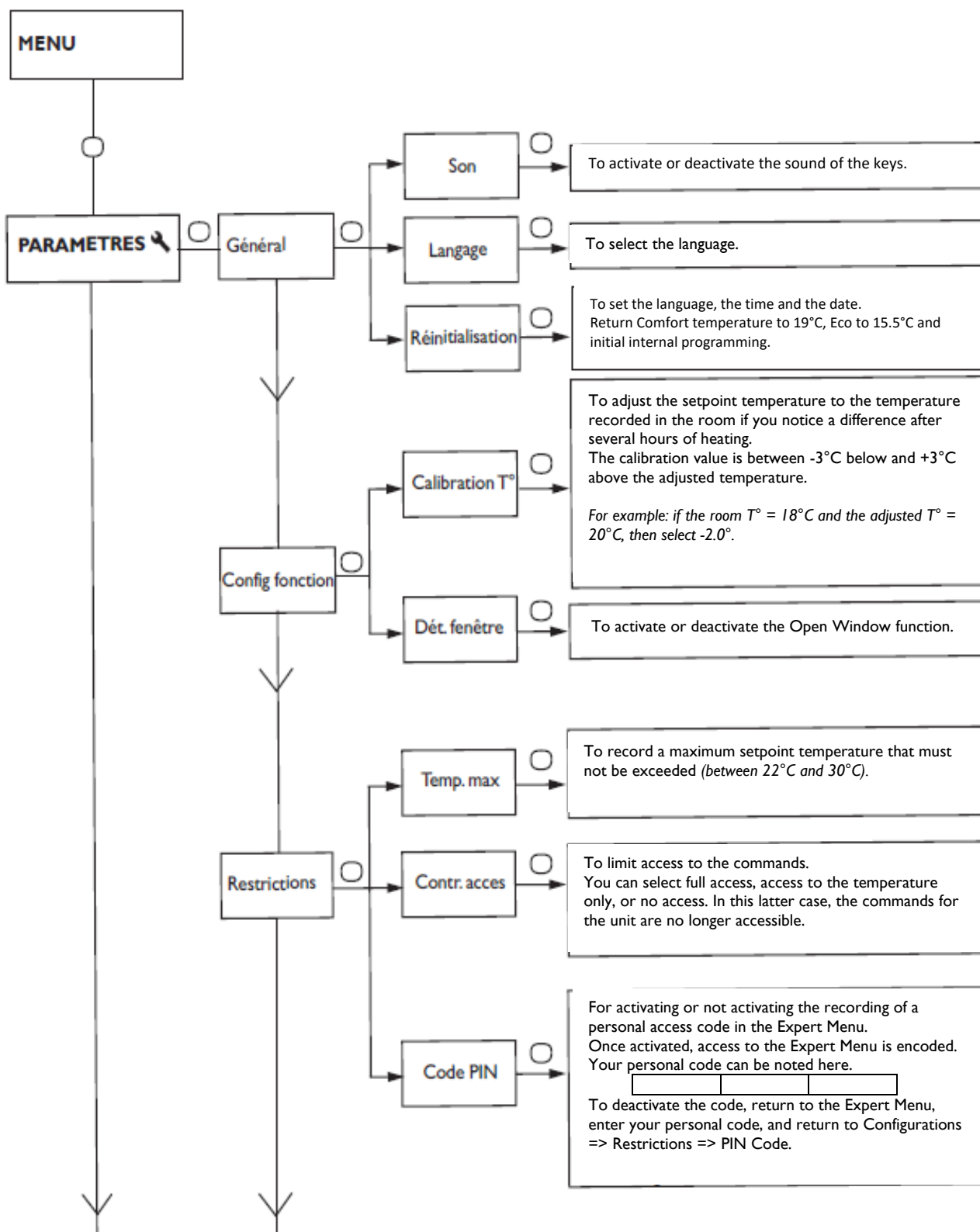



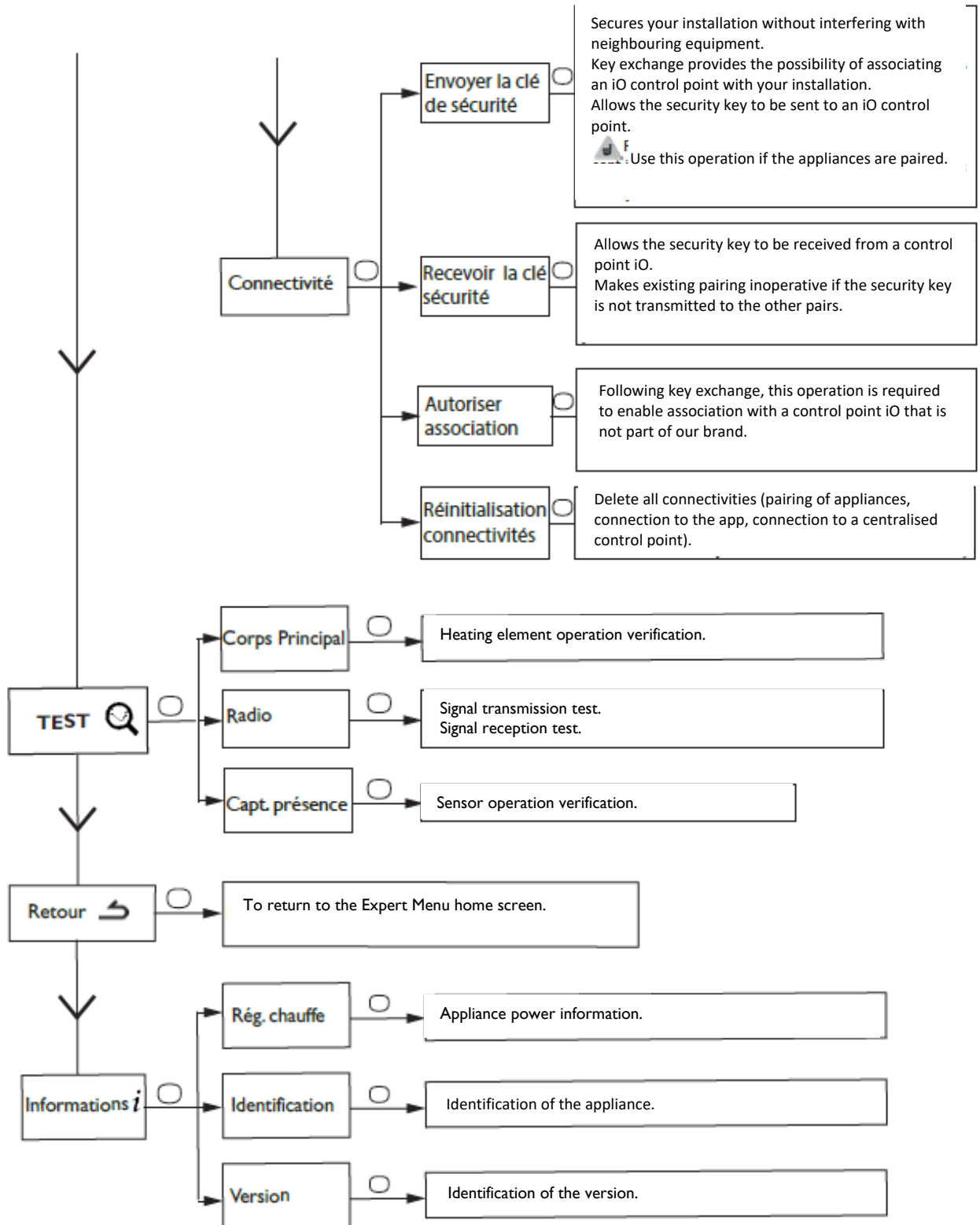

## Restrictions

---

You can restrict access to the temperature adjustment and to the modes. In the Basic mode or Prog mode or Auto mode menus.

Access Parameters , select "Restrict".

- The temperature will be fixed to a maximum of 23°C;
- A warning will appear if the temperature is increased, with a request for confirmation (compulsive overheating function);
- Access to the Expert Menu is secured using a PIN code.

Deactivation is possible by resetting the appliance (refer to the Expert Menu).

## Power cut-off

---











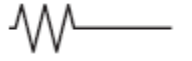



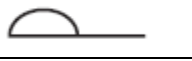

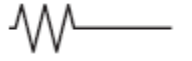
Our appliances are compatible with various power cut-off systems. However, you should not use power cut-off by interrupting the supply circuit power supply since this system is incompatible with our appliances. Sudden unintentional and repeated interruptions to the electrical power supply can cause premature wear and damage to the electronic boards that will not be covered by the manufacturer's warranty.

During power cut-off periods, the screen switches to standby.

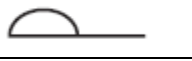
The appliance then returns to its initial operating mode.

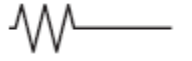
## Troubleshooting

Problem encountered.	Checks to be undertaken.
The control unit screen does not turn on.	Check that the switch located behind the appliance is in the I position. Check the power supply to the appliance.
The ambient temperature differs from that displayed on the appliance.	A period of at least 6 hours needs to elapse for the temperature to stabilise. It is possible, depending on your installation, that you will record a temperature that differs from that displayed on the appliance ( <i>a difference of 0.5° C is normal</i> ). In this case, refer to the "Expert Menu", "T° Calibration" chapter.
The appliance does not heat up.	If you have accessed programming, check that you are within a Comfort time window. Check that the installation's circuit-breakers are triggered or that the cut-off device ( <i>if present</i> ) has not interrupted the operation of the appliance. Check the air temperature in the room: if it is too high compared to the setpoint temperature, the appliance will not heat up.
The appliance heats up continuously.	Check that the appliance is not located in an air current ( <i>door open nearby, air escaping through the cable cover behind the appliance</i> ) or that the temperature adjustment has not been changed. There may be a problem in the electrical network. In the event of a problem ( <i>thermostat blocked, etc.</i> ), cut the power supply to the appliance ( <i>fuse, circuit-breaker</i> ) for approximately 10 minutes, then turn the appliance back on. If the phenomenon repeatedly occurs, check the power supply with your energy distributor.
The appliance does not heat up sufficiently.	Increase the temperature by pressing $\wedge$ (refer to the "Adjusting the temperature" chapter). If the adjustment is at the maximum, perform the following checks: - Check whether there is another form of heating in the room; - Ensure that your appliance only heats up the room ( <i>door closed</i> ); - Check the power supply voltage for the appliance; - Check whether the power of your appliance is suitable for the size of your room ( <i>we recommend an average of 100 W/m<sup>2</sup> for a ceiling height of 2.50 m or 40 W/m<sup>3</sup></i> ).
The surface of the appliance is very hot.	It is normal for the appliance to be hot when it operates, the maximum surface temperature is limited in accordance with the NF Electricity standard. However, if you feel that your appliance is always too hot, check that the power is suitable for the surface area of your room ( <i>we recommend 100 W/m<sup>2</sup> for a ceiling height of 2.50 m or 40 W/m<sup>3</sup></i> ) and that the appliance is not placed in an air current that could interfere with its adjustment.
Traces of dirt appear on the wall around the appliance.	In a polluted environment, dirt can appear on the appliance's air outlets or on the wall. This phenomenon is associated with poor ambient air quality ( <i>smoke from cigarettes, candles, incense, fireplaces, etc.</i> ). In this case, we recommend checking the correct ventilation of the room ( <i>ventilation, air inlet, etc.</i> ).
The Expert Menu is not accessible.	Have you entered a PIN code? You must enter your code to access the Expert Menu ( <i>refer to the Expert Menu chapter</i> ).
The appliance does not follow the internal programming instructions.	Check that the date and time are set. Check that the appliance is in PROG Mode and that internal programming is selected.

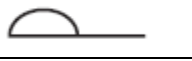
The appliance does not follow the external programming instructions.	Ensure that the programming unit is being used correctly ( <i>refer to the unit's operating instructions</i> ). Check that the appliance is in PROG Mode and "Ext. control" programming source is selected.																					
The appliance does not respond to the instructions from the pilot wire.	<p>Perform the following checks to check for the correct transmission of the programming instructions:</p> <table border="1" data-bbox="584 432 1375 887"> <thead> <tr> <th>Instructions received</th> <th>Oscilloscope Ref./ Neutral</th> <th>Mode obtained</th> </tr> </thead> <tbody> <tr> <td>0 Volt</td> <td></td> <td>COMFORT</td> </tr> <tr> <td>230 V 3 s/5 min</td> <td></td> <td>COMFORT – 1° C</td> </tr> <tr> <td>230V 7 s/5 min</td> <td></td> <td>COMFORT – 2° C</td> </tr> <tr> <td>230 V</td> <td></td> <td>ECO</td> </tr> <tr> <td>- 115 V negative</td> <td></td> <td>FROST PROTECTION</td> </tr> <tr> <td>+ 115 V positive</td> <td></td> <td>STOP HEATING</td> </tr> </tbody> </table> <p>Within the context of programming using the pilot wire or a carrier current, the <b>frost protection</b> or <b>power-cut off</b> instructions have priority. The delay for switching from the <b>Comfort</b> mode to the <b>Eco</b> mode is approximately 12 seconds. The delay for switching from the <b>Comfort -1/-2</b> mode to the <b>Comfort</b> mode is approximately 5 minutes.</p>	Instructions received	Oscilloscope Ref./ Neutral	Mode obtained	0 Volt		COMFORT	230 V 3 s/5 min		COMFORT – 1° C	230V 7 s/5 min		COMFORT – 2° C	230 V		ECO	- 115 V negative		FROST PROTECTION	+ 115 V positive		STOP HEATING
Instructions received	Oscilloscope Ref./ Neutral	Mode obtained																				
0 Volt		COMFORT																				
230 V 3 s/5 min		COMFORT – 1° C																				
230V 7 s/5 min		COMFORT – 2° C																				
230 V		ECO																				
- 115 V negative		FROST PROTECTION																				
+ 115 V positive		STOP HEATING																				

If you have been unable to resolve your problem, contact your distributor/installer, with the details of the appliance readily available. These are located on the side of the appliance. Record the room temperature.

The commercial Code (C) and the serial Number (E) will inform the manufacturer of the type of appliance that you have acquired.

- A** Standards, quality labels
- B** Brand name
- C** Commercial code
- D** Manufacturer's reference
- E** Serial No.
- F** Manufacturer's No.

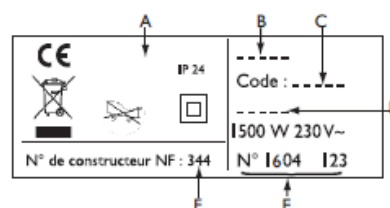

(non-contractual image)

<b>Technical Features measured and calculated according to REGULATION (EU) 2015/1188.</b>			
<b>Model references</b>	RCH-BD1C / RCV-BD1C		
Feature	Symbol	Value	Unit
<b>Thermal power</b>			
Nominal thermal power	Nom. P.	0.5 to 2.0	kW
Minimum thermal power	Min. P	0.0	kW

Maximum continuous thermal power	Max. P, c	2.0	kW
<b>Auxiliary electricity consumption</b>			
At nominal thermal power	Max. el	0.000	kW
At minimum thermal power	Min. el	0.000	kW
In standby mode	Sb. el.	0.00070	kW
<b>Thermal power / room temperature control type</b>			
Feature	Unit	Additional information	
Electronic control of the room temperature and weekly programmer.	yes		
<b>Other control options</b>			
Room temperature control, with presence detector.	yes		
Room temperature control, with open window detector.	yes		
Remote control option.	yes		
Adaptive control of activation.	yes		
Activation duration limitation.	no		
Black globe sensor.	no		
<b>Contact details</b>	Same as back cover		

# AGILIA

SMART ONLINE CONTROL



Thank you for choosing our product and for the confidence you have placed in us. Your recently acquired AGILIA Smart Online Control gentle warmth radiator has undergone numerous tests and inspections to ensure the best quality and to thus provide you with complete satisfaction.





## WARRANTY

DOCUMENT TO BE RETAINED BY THE USER,  
ONLY TO BE SUBMITTED IN THE EVENT OF A CLAIM

- The warranty period is for 2 years from the date of installation or purchase and cannot exceed 30 months from the date of manufacture without justification. Atlantic covers the exchange or the provision of parts acknowledged as defective, excluding any damage and interests.
- The user is responsible for labour, travel and transportation costs.
- Any damage resulting from a non-compliant installation or from a power supply network that does not comply with standard NF EN 50160, or from improper use or from non-compliance with the provisions of said instructions, is not covered by the warranty.
- The provisions of these warranty conditions do not prevent the buyer from benefiting from the advantages of the legal warranty for latent faults and defects that in any case are applicable according to the conditions of articles 1641 and following of the Civil Code.
- Only submit the certificate in the event of a claim with the distributor or your installer, accompanied by your purchase invoice.

TYPE OF APPLIANCE\*:

SERIAL NO.\*:

CUSTOMER'S NAME AND ADDRESS:

\* This information is found on the identification plate on the left-hand side of the appliance.

BIP  
Rue Monge - BP 65  
F-85002 LA ROCHE SURYON

[www.atlantic.fr](http://www.atlantic.fr)

Distributor's stamp

Any disputes fall within the exclusive  
jurisdiction of the courts of La Roche-sur-Yon

Version - May 2017  
U060 5438/A



atlantic-heat.co.uk

T: 0844 3350 549 F: 0844 5436 180  
E: [enquiries@atlantic-heat.co.uk](mailto:enquiries@atlantic-heat.co.uk)  
Atlantic Heat | PO Box 103, National Avenue,  
Kingston Upon Hull, HU5 4JN

Atlantic Heat is part of Ideal Boilers Limited. Ideal Boilers Ltd. pursues a policy of continuing improvement in the design and performance of its products. The right is therefore reserved to vary specification without notice.

 GROUPE  
**ATLANTIC**  
UK, ROI & NORTH AMERICA DIVISIONS