



DELTA Ultimate

Towel Rails

Instruction Manual

Assembly, installation, start-up
and operating instructions

e·life
technology



Class II





Thank you.

Many thanks for your confidence in our Rointe products. Before you start to use the low-consumption digital electrical Delta Ultimate towel rails we recommend that you read this manual carefully in order to use the product correctly with the maximum guaranteed results.

INDEX

| | |
|-------------------------------------------------------|----|
| 1. Description of the DELTA Ultimate Towel Rails..... | 4 |
| 1.1. Description of the front panel | 5 |
| 1.2. Switch on and off (Stand By) | 8 |
| 1.3. Select temperature..... | 9 |
| 1.4. Lock the control panel | 9 |
| 1.5. Adjust date and time | 10 |
| 1.6. Main Menu | 11 |
| 1.7. Open Window Function | 26 |
| 2. Installation and Mounting | 27 |
| 3. Dimensions | 28 |
| 4. Connection guidelines | 29 |
| 4.1. Special rules for bathrooms | 30 |
| 5. Maintenance and Cleaning..... | 31 |
| 5.1. Safety | 31 |
| 6. Guarantee..... | 32 |

1. DESCRIPTION OF THE “DELTA ULTIMATE” TOWEL RAILS

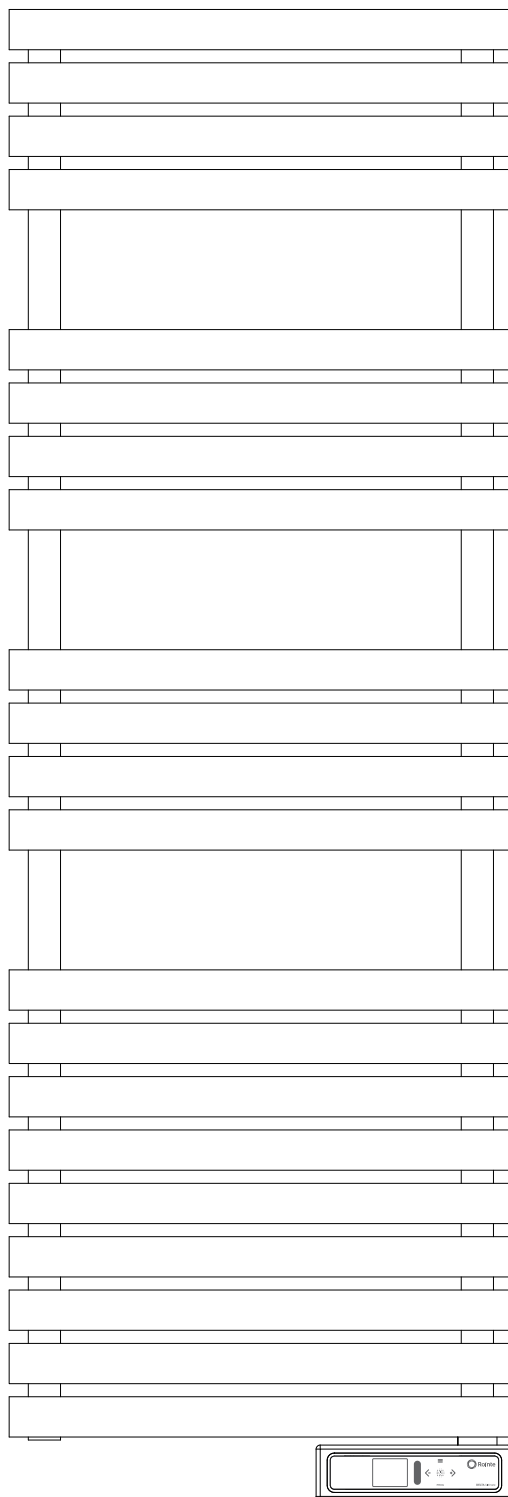



1.1. Description of the front panel





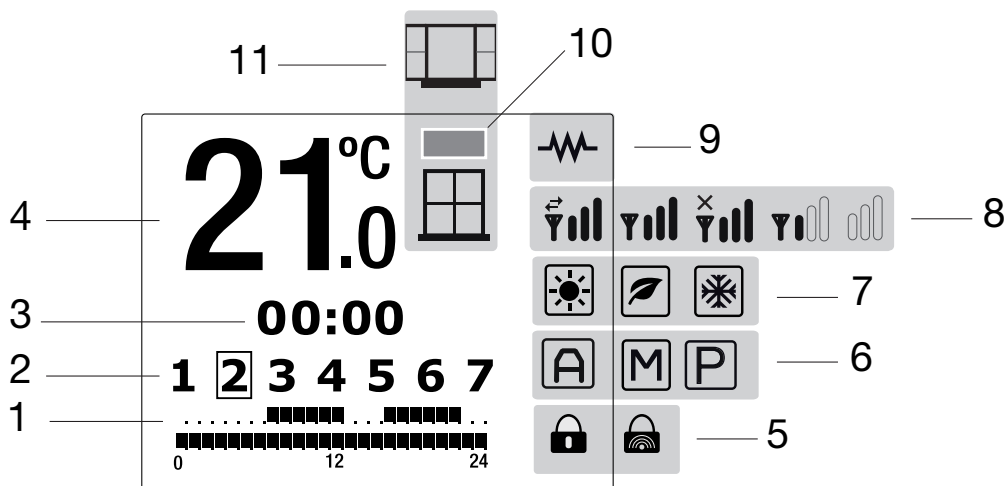















| ICON | INDICATION |
|------|-------------------------------------|
| | On / Off - Accept |
| | Decrease temperature - Move left |
| | Increase temperature - Move right |
| | Access/Return to Menu - Move up |
| PROG | Access programming Menu - Move down |

1.1.1 Parts of the TFT screen









| NUM. | INDICATION |
|-------------------------------------------------------------------------------------|---------------------------------------------|
| 1 | Hours programmed - AUTO |
| 2 | Days of the week |
| 3 | Time |
| 4 | Selected temperature |
| 5 | Locking the control panel |
| 6 | Manual / Automatic / Pilot wire functions |
| 7 | Comfort / Economy / Anti-frost modes |
| 8 | Net connection status |
| 9 | Heating Element in operation |
| 10 | Consumption behaviour indicator |
| 11 | Open Windows function |
| ICON | DESCRIPTION |
|  | Open Windows function active - No detection |
|  | Open Windows function - Detected |

| | |
|-------------------------------------------------------------------------------------|-----------------------------------------------------------------|
|  | Consumption indicator – green / yellow / red |
|  | Towel Rail Heating element on |
|  | Connected to the router and server - sending and receiving |
|  | Connected to the router and server - maximum internet signal |
|  | Connected to the router and server - minimum internet signal |
|  | Connected to router but not connected to server nor internet |
|  | Not connected to server. Not connected to the router |
|  | Comfort Mode activated |
|  | Eco mode activated |
|  | Anti-frost mode activated |
|  | Automatic mode activated |
|  | Manual mode activated |
|  | Pilot Wire Control mode activated |
|  | Automatic function activated in USER mode |
|  | Manual function activated in USER mode |

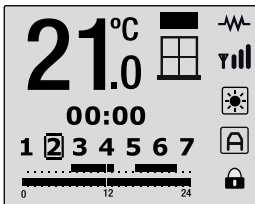
| | |
|-----------------------------------------------------------------------------------|---------------------------------------------------------------------|
|  | Pilot Wire Control function activated in USER mode |
|  | Product locked via towel rail control panel |
|  | Product locked via Air Control remote control or Rointe Connect App |

1.2. Switch On and Switch Off (Stand-by)

| | |
|------------------------------------------------------------------------------------------------------------------------------------------------------------------------------------------------------------------------------------------------------|---------------------------------------------------------------------------------------|
| <p>The Delta Ultimate towel rail is switched on or off using the  button. The following welcome appears on the TFT screen when the towel rail is switched on.</p> |  |
| <p>The main temperature screen will appear after 5 seconds.</p> |  |
| <p>If you press the  button again when the towel rail is switched on it will revert to stand-by mode and the words “Stand-By” will appear.</p> |  |
| <p>5 seconds later and the Rointe logo will appear.</p> |  |

1.3. Temperature selection

You can change the desired temperature using the keys <- or +>. If the temperature of the room is less than is desired then the towel rail will begin to heat up and the  symbol will appear.

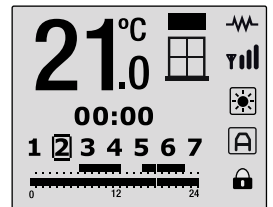

1.4. Locking the control panel

You can lock the product from the actual control panel of the towel rail or remotely via the Rointe Connect App or the Air Control remote control.

On the product control panel you can lock the keypad by pressing and holding down the <- and +> buttons at the same time for 3 seconds. The locked icon  will appear. When you press any button the image on the right will appear on the screen. You can unlock the product again by pressing and holding down the <- and +> buttons for 3 seconds.

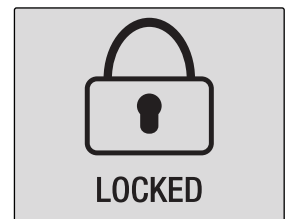





If we lock the product via the application or remote control then the remote locked icon will appear on the screen . When you press any button on the towel rail control panel, the image on the right will appear on the screen. If the product is locked in this way, you can only unlock the towel rail via the Rointe Connect app or the Air Control remote control.







1.5. Adjusting time and date

It is possible to change the time on the towel rail from the control panel. However it is better to wait for the automatic synchronization once the product has been paired with the Rointe Connect app. and the product is connected to the E-Life technology servers.



Here we explain how to change the time from the towel rail control panel.

Press the menu button  to access the main menu. Select the sub-menu  by using the  and  buttons then press  to access.



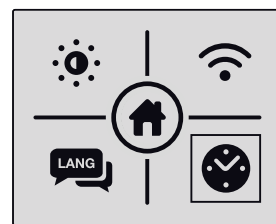





In the configuration sub-menu, use the  and  buttons to select the clock  then press  to access.



| | |
|--------------------------------------------------------------------------------------------------------------------------------------------------------------------------------------------------------------------------------------------------------------------------------------------------------------------------------------------------------------------------------------------------------------------------------------------------------------------|--------------------------------------------------------------------------------------------------------------------------------------------------|
| <p>By pressing the  button, the hours, minutes and days will flash depending on the number of times the button is pressed (1 for hours, 2 for minutes and 3 for the day of the week).</p> <p>We can change any of these by pressing the < or > buttons. To confirm, press the  button.</p> | <div style="border: 1px solid black; padding: 10px; text-align: center;"> <p>SET TIME</p> <p>10:50</p> <p>1 <u>2</u> 3 4 5 6 7</p> </div> |
|--------------------------------------------------------------------------------------------------------------------------------------------------------------------------------------------------------------------------------------------------------------------------------------------------------------------------------------------------------------------------------------------------------------------------------------------------------------------|--------------------------------------------------------------------------------------------------------------------------------------------------|

To exit the time/day mode wait 30 seconds or press the  button after selecting the day of the week.

1.6. Main menu





| | | | | |
|------------------------------------------------------------------------------------------------------------------------------------------------------------------------------------------------------------------------------------------------------------------------------------------------------------------------------------------------------------------------------------------------------------------------------------|-------------------------------------------------------------------------------------|-------------------------------------------------------------------------------------|---------------------------------------------------------------------------------------|---------------------------------------------------------------------------------------|
| <p>Press the  button to access the main menu of your Delta Ultimate towel rail. You can move between the different options on the menu by pressing the < and > buttons. The sub-menu which you have selected will be highlighted with a frame. The following icons allow you to access different sub-menus which we will now explain:</p> | | | |  |
|  |  |  |  | |
| <p>Configuration Sub-Menu</p> | <p>Energy Sub-Menu</p> | <p>Balance Function</p> | <p>Programming Sub-Menu</p> | |

1.6.1. Configuration sub-menu

The configuration sub-menu consists of 4 technical parameters of the product.

To access this menu, press  on the main menu screen. The screen on the right will appear and we can move between the various options of the sub-menu by using the <- and +> buttons. We can access the various sub-menus, which we can now explain, using the following icons:



| | | | |
|-------------------------------------------------------------------------------------|-------------------------------------------------------------------------------------|-------------------------------------------------------------------------------------|-------------------------------------------------------------------------------------|
|  |  |  |  |
| Screen backlight | Internet settings | Language | Adjust day / time |

- Screen backlight function 

This function allows you to change the brightness of the screen in the STAND-BY and BACKLIGHT (ON) modes. We can change between the 2 modes by using the  and PROG buttons.

We can increase or decrease the brightness by using the <- and +> buttons.

The cursor shows the intensity of the light within the range. Press the  button to confirm and to exit.

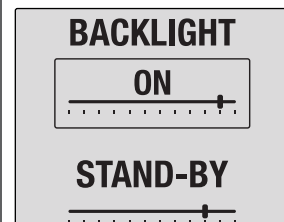

- Internet Settings 

This option prepares the product to communicate with a special network enabling it to be paired. Press the internet settings option  to access this mode.

On the next screen the name of the WIFI network (NET) and password (PIN) which have been created will appear.

Exit the PAIRING mode by pressing the  button which will allow us to return to the main screen.

NET: ROR_0001
PIN: 12345678

000000000000
000000000000



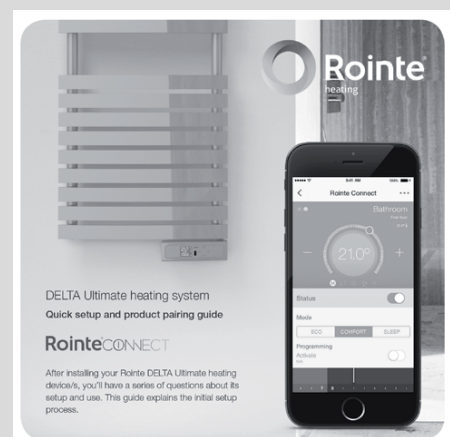

Pairing your product with the Rointe Connect App

In order to pair your Rointe Delta Ultimate product(s) with your local WI-FI signal, please follow the instructions in the attached document “Delta Ultimate. Quick set-up guide.



- Language 

You can select the language you wish using this function. Select the language you wish by pressing the  and  buttons. Press the  button to confirm the language highlighted.





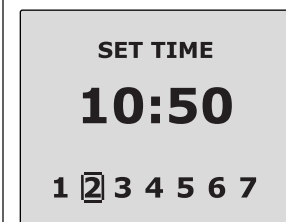

- Adjust date / time 





This function allows you to change the hour, minutes and day of the week on the product control panel. To adjust the time/date please revert to section 1.5.

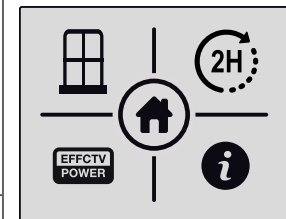

1.6.2. Energy Sub-menu

The Energy Sub-menu allows access to the functions relating to the energy management of the product. Select the icon  from the main menu by using the  and  buttons. Press  to access this screen. The following icons allow you to access distinct sub-menus:









| | | | |
|-------------------------------------------------------------------------------------|-------------------------------------------------------------------------------------|-------------------------------------------------------------------------------------|-------------------------------------------------------------------------------------|
|  |  |  |  |
| Open windows function | Two-hour Boost mode | Effective power function | Information |

- Open Windows Function 

| | |
|-------------------------------------------------------------------------------------------------------------------------------------------------------------------------------------------------------------------------------------------------------------------------------------------------------------------------------------------------------------------------------------------------------------------------|-----------------------------------------------------------------------------------------------------------------------------------------------------------------------------------------------------------------------|
| <p>This option allows you to turn on or turn off the open Windows function. Select ON to activate it or OFF to deactivate it by using the \equiv and <small>PROG</small> buttons. To confirm the desired option and exit, press the  button. To learn more about this function please see section 1.7 of this manual.</p> | <div style="border: 1px solid black; padding: 5px; text-align: center;"> <p>OPEN WINDOWS</p> <div style="border: 1px solid black; padding: 2px; margin: 2px auto; width: 60px;">ON</div> <p>OFF</p> </div> |
|-------------------------------------------------------------------------------------------------------------------------------------------------------------------------------------------------------------------------------------------------------------------------------------------------------------------------------------------------------------------------------------------------------------------------|-----------------------------------------------------------------------------------------------------------------------------------------------------------------------------------------------------------------------|

 This function activates the Anti-Frost mode (7°C) when the towel rail sensor detects a drop of at least 4°C in 30 minutes.

- Two-hour Boost Mode 

| | |
|---------------------------------------------------------------------------------------------------------------------------------------------------------------------------------------------------------------------------------------------------------|------------------------------------------------------------------------------------------------------------------------------------------------------------------------------------------------------------------------------------------------------------------------------------------------------------------------------------------------------------------------------------------------------------------------------------------------------------------------------------------------------------------------------------------------------------------------------------------------------------------------------------------------------------------------------------------------------------------------------------------------------------------------------------------------------------------------|
| <p>This function sets the towel rail to work for two hours at maximum power, regardless of any other mode. This mode takes priority over any other.</p> <p>When the heated towel rail is set on the two-hour mode, the screen will show this image.</p> | <div style="border: 1px solid black; padding: 10px; text-align: center;"> <p>2H</p> <p>MAX POWER</p> </div> |
| <p>Once the towel rail is set on the two-hour mode, and until the two hours have finished or the key is pressed again, the display will show this image.</p> | <div style="border: 1px solid black; padding: 5px;"> <div style="display: flex; justify-content: space-between; align-items: center;"> <div style="text-align: center;">  <p>00:00</p> <p>1  3 4 5 6 7</p> </div> <div style="text-align: right;">     </div> </div> </div> |

- Effective Power Function



This function shows the working time and total time that the product has been connected on the main screen.

The nominal and effective power will appear on the screen after 6 seconds without pushing any buttons.

WORKING TIME
000001h

TOTAL TIME
000001h

POWER(W)
2000
EFFECTIVE
POWER(W)
400





The effective power is the actual consumption of our product during the total time it is switched on.

- Information









This option shows the software version, the release date and the nominal power of the product.



Select the  icon by using the <- and +> buttons, then press the  button to confirm. To exit from the information screen, press ≡.

SOFTWARE
VERSION
V1.00

19/02/2015
POWER 750W



| | |
|--------------------------------------------------------------------------------------------------------------------------------------------------------------------------------------------------------------------------------------------------------------------------------------------------------------------------------------------------------------------------------------------------------------------------------------------------------------------------------------------------------------|-----------------------------------------------------------------------------------------------------------------------------------------------------------------------------------------------------------------------------------------------------------------------------|
| <p>This option shows the status of the WIFI connection, the IP address, subnet mask and connection port.</p> <p>Select the  icon by using the <- and +> buttons then press the  button to confirm. To exit from the information screen, press .</p> | <div style="border: 1px solid black; padding: 5px; background-color: #f0f0f0;"> <p>WIFI STATUS dhcp:assigned IP, NM, GW: XXX.XXX.X.XXX XXX.XXX.XXX.X XXX.XXX.X.XXX</p> </div> |
| <p>This option shows the MAC and RSSI address and signal strength which is measured in dbm.</p> <p>Select the  icon by using the <- and +> buttons then press the  button to confirm. To exit from the information screen, press .</p> | <div style="border: 1px solid black; padding: 5px; background-color: #f0f0f0;"> <p>WIFI STATUS MAC: 0 :50:93 C4:03:F6 RSSI:-70</p> </div> |

1.6.3. Balance Sub-menu

| | |
|-------------------------------------------------------------------------------------------------------------------------------------------------------------------------------------------------------------------------------------------------------------------------------------------------------------------------------------------------------------------------------------------------------------------------------------------------------------------------------------------------------------------------------|-------------------------------------------------------------------------------------------------------------------------------------------------------------------------------------------------------------------------------------------------------------------------------------------------------------------------------------------------------------------------------------------------------------------------------------------------------------------------------------------------------------------------------------------------|
| <p>The balance sub-menu forces the towel rail to work in manual mode at a constant 19°C.</p> <p>Select the  icon from the main menu using the <- and +> buttons.</p> <p>Press the  button to confirm. By pressing this button the towel rail will return to the main screen with a set temperature of 19°C and the “Manual” icon will appear.</p> | <div style="border: 1px solid black; padding: 5px; background-color: #f0f0f0;"> <p style="font-size: 2em; font-weight: bold;">19.0</p> <p style="font-size: 1.2em; font-weight: bold;">10:50</p> <p style="font-size: 1.2em; font-weight: bold;">1 2 3 4 5 6 7</p> <p style="font-size: 0.8em;">0 12 24</p> <div style="display: flex; justify-content: space-between; align-items: center;"> <div style="font-size: 0.8em;"> <p>☰</p> <p>☀</p> <p>M</p> </div> <div style="font-size: 0.8em;"> <p>📶</p> <p>☀</p> <p>M</p> </div> </div> </div> |
|-------------------------------------------------------------------------------------------------------------------------------------------------------------------------------------------------------------------------------------------------------------------------------------------------------------------------------------------------------------------------------------------------------------------------------------------------------------------------------------------------------------------------------|-------------------------------------------------------------------------------------------------------------------------------------------------------------------------------------------------------------------------------------------------------------------------------------------------------------------------------------------------------------------------------------------------------------------------------------------------------------------------------------------------------------------------------------------------|

1.6.4. Programming sub-menu

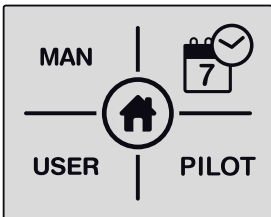
In this section we will explain the aspects of the towel rails in relation to how they work in their various functions and modes.

| | | | | |
|-----------------------------------------------------------------------------------------------------------------------------------------------------------------------------------------------------------------------------------------------------------------------------------------------------------------------|------------------------------------------------------------------------------------|---------------|---------------------------------|--------------------------------------------------------------------------------------|
| <p>The programming sub-menu provides access to the functions related to programming the product. Select the  icon from the main menu. The icons shown below allow access to the distinct sub-menus which we will describe later:</p> | | | |  |
| MAN / AUTO |  | USER | PILOT | |
| Manual / Automatic Function | Start Programming | User Function | Pilot Wire Mode (Only Class II) | |

What are the manual, automatic and pilot wire modes?



Manual Mode

This mode allows you to change between comfort, eco and anti-frost modes changing the temperature as described in section 1.3.

Automatic Mode

This mode activates the programming which has been set in the towel rail.

Pilot Wire Mode

This mode allows you to control the towel rail via a central control.

What are the comfort, Eco and Anti-Frost modes?

i These modes represent different ranges of temperatures available within the products.

| Icon | Mode | Temperature Range |
|-----------------------------------------------------------------------------------|------------|----------------------|
|  | Comfort | From 19°C to 30°C |
|  | Eco | From 7.5°C to 18.5°C |
|  | Anti-Frost | 7°C |

- Manual/Automatic Function MAN/AUTO

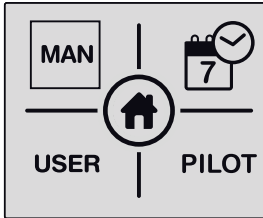
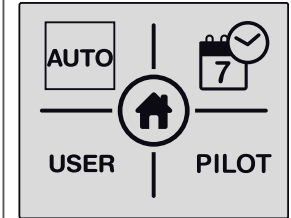
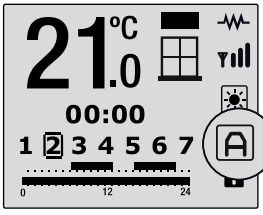
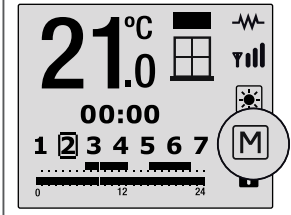
| | | |
|-------------------------------------------------------------------------------------------------------------------------------------------------------------------------------------------------------------------------------------------|--------------------------------------------------------------------------------------|---------------------------------------------------------------------------------------|
| <p>Press the  button to change between the Manual and Automatic modes.</p> |  |  |
| <p>On the main screen the symbol A will appear in Automatic mode and the symbol M will appear in Manual mode.</p> |  |  |

i The Automatic Mode will activate the programming which you have already set in the product.

- Start Programming



To start programming, use the <- and +> buttons to choose the icon and confirm by pressing the button.

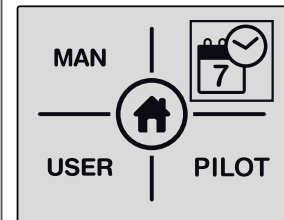

1 ●●● Select the COMFORT temperature

Use the <- and +> keys to select the COMFORT temperature, between 19°C and 30°C. The ☀ symbol and the temperature will flash. Once selected, press to confirm.



2 ●●● Select the ECO temperature

Continue and select the ECO temperature, between 7.5°C and 18.5°C. The 🍃 symbol and the temperature will flash. Press to confirm.

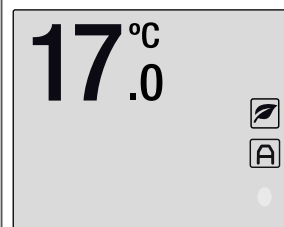

3 ●●● Select DAYS

After pressing the button, the days of the week will flash showing the days as Day1, Day 2 etc. We can use the <- and +> buttons to go forwards or backwards through the days. Press the button to select the day or days which you wish to program with the same programming.

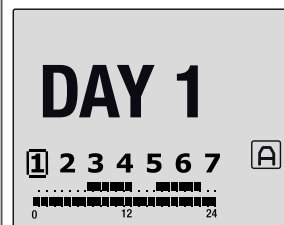

●●●●4 Assign mode to each HOUR

To access the hourly programming of the chosen days press ➤ until you pass day number 7.

You can move back and forward between the hours by using the <- and ➤ buttons. The hours are shown as 0h, 1h, 2h...

By using the ☼ button you can chose between the COMFORT, ECO and OFF modes.

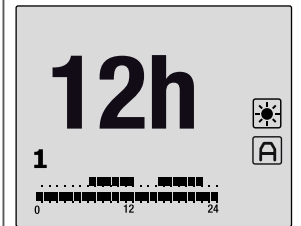

Once the hours of the selected days have been programmed, press ≡ or wait 30 seconds without touching any button.

You can program day by day or you can program several days at the same time.

User Function USER

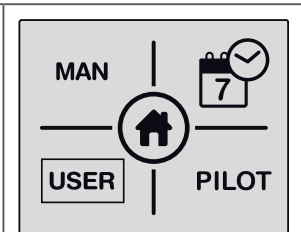

To access the User Function, use the <- and ➤ buttons to select the USER icon and confirm by pressing ☼.





i **USER Function**

This allows the user to establish a limited working temperature range (maximum and minimum temperature).

By way of a 4 digit code you can access a menu where you can activate or deactivate this function, change the password and fix a maximum and minimum temperature range for the product

When the product is working with this function one of the following symbols will appear on the main screen    depending on whether it is in Automatic mode, Manual mode or Pilot Wire mode.

Enter the PIN to access. The default PIN number is 0000.

Select the numbers by using the  and  buttons and confirm by pressing .

Press OK to access. If the pin number is wrong then the words “INCORRECT PIN” will appear on the screen.

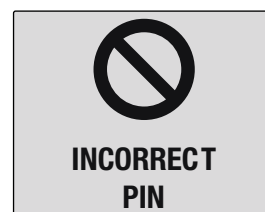
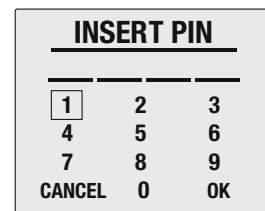

When the PIN number has been entered correctly the main screen of the basic configuration will appear.

The following icons allow access to the various sub-menus which we will now describe:

| ACTIVATE | CHANGE PWRD | UPPER LIMIT | LOWER LIMIT |
|------------------------------|-----------------|---------------------------|---------------------------|
| Activate/Deactivate Function | Change Password | Maximum Temperature Limit | Minimum Temperature Limit |

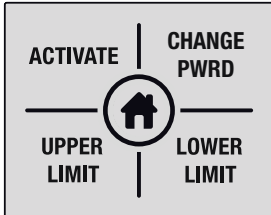

- Activate function **ACTIVATE**

Allows you to activate or deactivate the USER function. Select ON to activate or OFF to deactivate the function by using the \equiv and **PROG** buttons. Once the chosen mode has been selected, press \odot to select and exit.

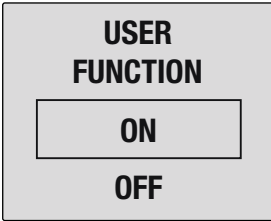

The icon **A.** or **M.** will appear at the top of the screen depending whether it is on Automatic mode or Manual mode.

If the product is in Pilot Wire Mode then the **P.** icon will appear.

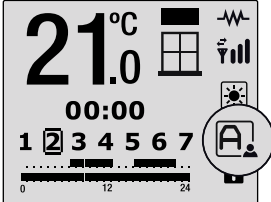

- Change Password CHANGE PWRD

This allows you to change the password to access the USER function. In order to change the password it will initially ask for the actual pin number. As we have seen previously the default pin number is 0000. Select the numbers by using the <- and +> then confirm by pressing 

If the PIN number is incorrectly entered, “INCORRECT PIN” will show on the screen and it will return to the previous screen.

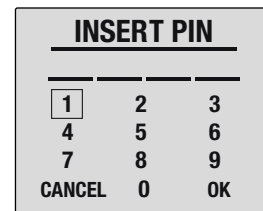

If the pin is correct then a screen will appear with the words “NEW PIN” asking you for a new pin number and this can be entered in the same way as before.

Once the new pin has been entered, confirm by selecting OK and the words “PIN CHANGED” will appear on the screen.

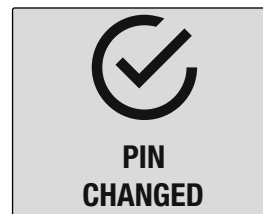
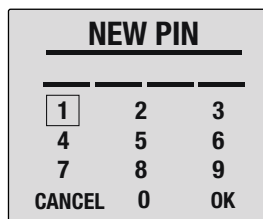

- Maximum temperature **UPPER LIMIT**

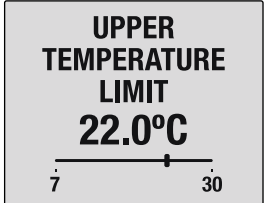

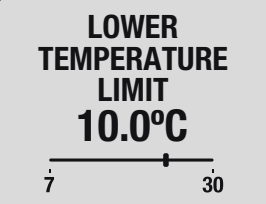

| | |
|--------------------------------------------------------------------------------------------------------------------------------------------------------------------------------------------------------------------------------------------------------------------------------------------------------------------------------------|-------------------------------------------------------------------------------------|
| <p>This allows you to set the maximum working temperature of the towel rail. Using the <- and +> buttons you can increase or reduce the temperature between 19°C and 30°C. Press  to exit once the desired temperature has been chosen.</p> |  |
|--------------------------------------------------------------------------------------------------------------------------------------------------------------------------------------------------------------------------------------------------------------------------------------------------------------------------------------|-------------------------------------------------------------------------------------|

- Minimum temperature **LOWER LIMIT**

| | |
|-----------------------------------------------------------------------------------------------------------------------------------------------------------------------------------------------------------------------------------------------------------------------------------------------------------------------------------------|---------------------------------------------------------------------------------------|
| <p>This allows you to set the minimum working temperature of the towel rail. Using the <- and +> buttons you can increase or reduce the temperature between 7.5°C and 18.5°C. Press  to exit once the desired temperature has been chosen.</p> |  |
|-----------------------------------------------------------------------------------------------------------------------------------------------------------------------------------------------------------------------------------------------------------------------------------------------------------------------------------------|---------------------------------------------------------------------------------------|

To exit, press the  button or wait 30 seconds.

- Pilot Wire Function **PILOT**

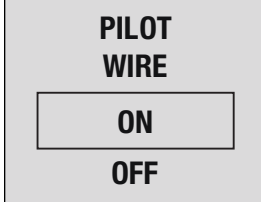
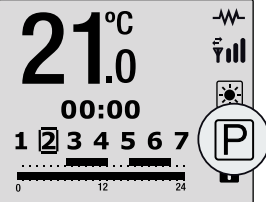
| | | |
|---------------------------------------------------------------------------------------------------------------------------------------------------------------------------------------------------------------------------------------------------------------------------------------------------------------------------------------------------------------------------------------------------------------------------------------------------------------------------------------------------------------------------------------------------|--------------------------------------------------------------------------------------|---------------------------------------------------------------------------------------|
| <p>Activate or deactivate the Pilot Wire Control function. Select ON to activate or OFF to deactivate by using the keys  and . Press  to confirm and exit. The symbol  will appear on the screen.</p> |  |  |
|---------------------------------------------------------------------------------------------------------------------------------------------------------------------------------------------------------------------------------------------------------------------------------------------------------------------------------------------------------------------------------------------------------------------------------------------------------------------------------------------------------------------------------------------------|--------------------------------------------------------------------------------------|---------------------------------------------------------------------------------------|

⚠ WARNING!





The Pilot Wire function only allows you to control your heating via the pilot wire programmer not via the Rointe Connect App.

1.7. Open Windows Function

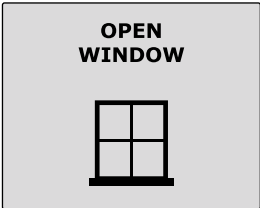
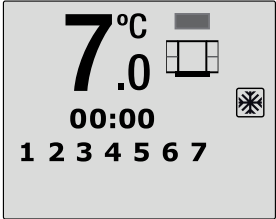
This function is activated when the towel rail sensor detects a drop of 4°C in the set temperature within a period of half an hour.

| | |
|------------------------------------------------------------------------------------------------------------------------------------------------------------------------------------------------------------------------|---------------------------------------------------------------------------------------|
| <p>When this function is activated the image on the right will appear on the towel rail screen for 5 seconds:</p> |  |
| <p>When the “Open Windows” mode is activated, the towel rail will pass into Anti-Frost 7°C mode. The following screen will appear on the towel rail screen indicating that the Anti-Frost mode has been activated.</p> |  |

This mode will be active for 2 hours. If the  button is pushed during this period of time then towel rail will switch off.

You can switch the towel rail on again by pushing the  button and it will work without the “open windows” function.

2. MOUNTING INSTRUCTIONS

Inside the box you will find a mounting kit.

1. Choose the right part of the wall.
2. Place the mounting stencil on the wall, marking the places for the holes.
3. Remove the stencil and make the holes in the wall.
4. Insert the rawl plugs in the holes made.
5. Screw the four metallic fasteners to the wall with the 6.3 x 50 mm screw.
6. Screw the four metallic cylinders to the towel rail like in Figure 1.
7. Insert what you have assembled in Section 6 into the metallic fastener and fix well with the 2.9 x 9.5 mm stud bolt.

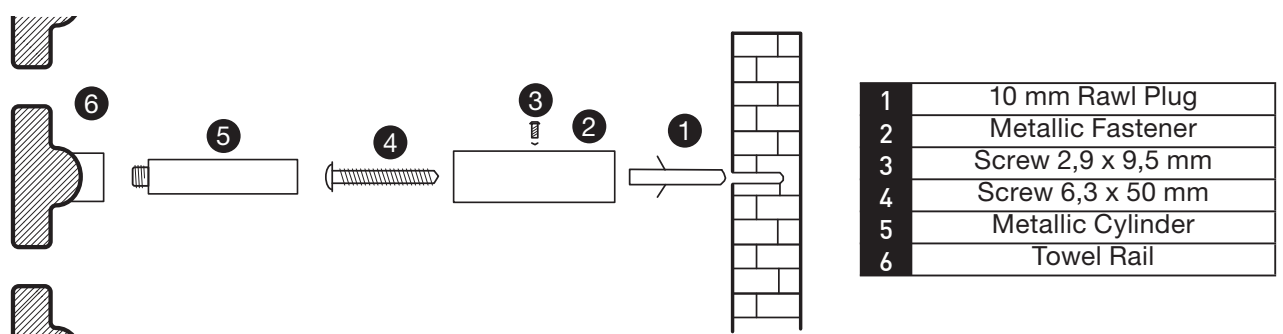

Cross section of the towel rail

Figure 1

3. SIZES

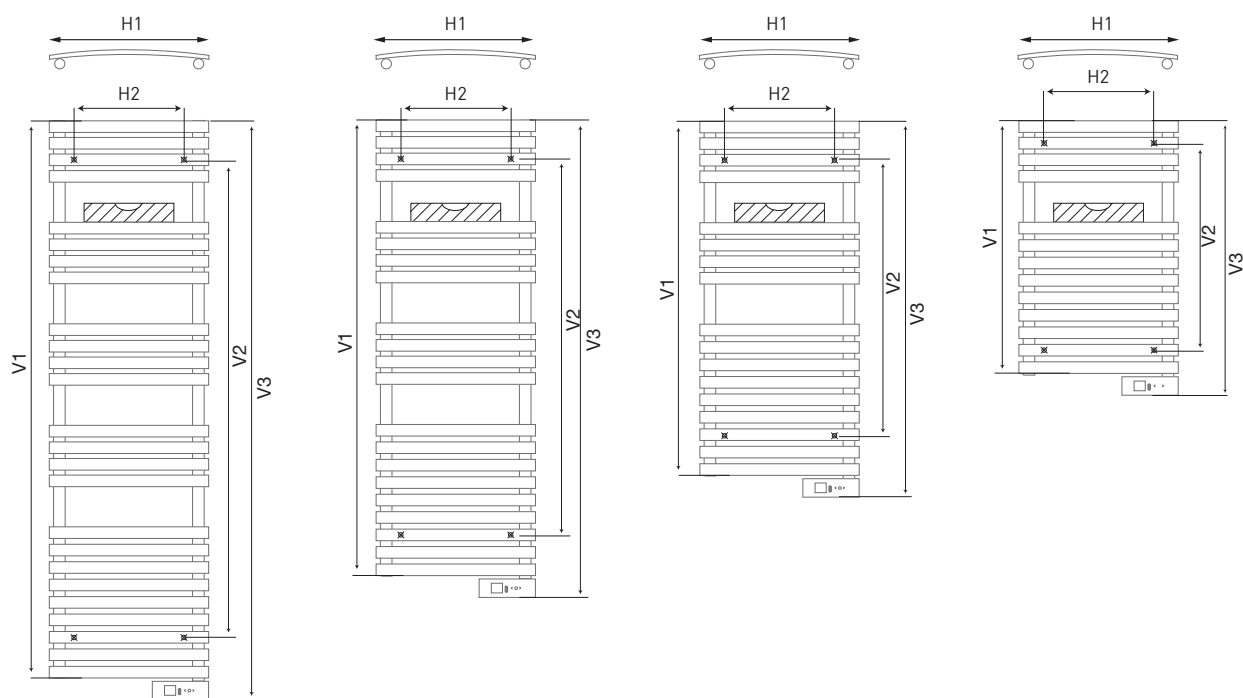

| REFERENCE | H1 | H2 | V1 | V2 | V3 |
|-----------|--------|--------|----------|----------|----------|
| DTI030*** | 500 mm | 287 mm | 788 mm | 637 mm | 843 mm |
| DTI045*** | 500 mm | 287 mm | 1,106 mm | 847 mm | 1.161 mm |
| DTI060*** | 500 mm | 287 mm | 1,420 mm | 1.167 mm | 1.475 mm |
| DTI075*** | 500 mm | 287 mm | 1,742 mm | 1.348 mm | 1.797 mm |

| CODE | MODEL | POWER | VOLTAGE | HEIGHT | WIDTH | DEPTH | INST.DEPTH | WEIGHT |
|-----------|-----------|-------|---------|----------|--------|-------|------------|--------|
| DTI030SEW | WHITE 030 | 300 W | 230V~ | 843 mm | 500 mm | 55 mm | 100 mm | 13 kg |
| DTI045SEW | WHITE 045 | 450 W | 230V~ | 1.161 mm | 500 mm | 55 mm | 100 mm | 17 kg |
| DTI060SEW | WHITE 060 | 600 W | 230V~ | 1.475 mm | 500 mm | 55 mm | 100 mm | 21 kg |
| DTI075SEW | WHITE 075 | 750 W | 230V~ | 1.797 mm | 500 mm | 55 mm | 100 mm | 25 kg |

| CODE | MODEL | POWER | VOLTAGE | HEIGHT | WIDTH | DEPTH | INST.DEPTH | WEIGHT |
|-----------|--------------|-------|---------|----------|--------|-------|------------|--------|
| DTI030SEB | GRAPHITE 030 | 300 W | 230V~ | 843 mm | 500 mm | 55 mm | 100 mm | 13 kg |
| DTI045SEB | GRAPHITE 045 | 450 W | 230V~ | 1.161 mm | 500 mm | 55 mm | 100 mm | 17 kg |
| DTI060SEB | GRAPHITE 060 | 600 W | 230V~ | 1.475 mm | 500 mm | 55 mm | 100 mm | 21 kg |
| DTI075SEB | GRAPHITE 075 | 750 W | 230V~ | 1.797 mm | 500 mm | 55 mm | 100 mm | 25 kg |

| CODE | MODEL | POWER | VOLTAGE | HEIGHT | WIDTH | DEPTH | INST.DEPTH | WEIGHT |
|-----------|------------|-------|---------|----------|--------|-------|------------|--------|
| DTI030SEC | CHROME 030 | 300 W | 230V~ | 843 mm | 500 mm | 55 mm | 100 mm | 13 kg |
| DTI045SEC | CHROME 045 | 300 W | 230V~ | 1.161 mm | 500 mm | 55 mm | 100 mm | 17 kg |
| DTI060SEC | CHROME 060 | 450 W | 230V~ | 1.475 mm | 500 mm | 55 mm | 100 mm | 21 kg |
| DTI075SEC | CHROME 075 | 600 W | 230V~ | 1.797 mm | 500 mm | 55 mm | 100 mm | 25 kg |

4. CONNECTION INSTRUCTIONS

Connection to the mains must be made observing the voltage stated on the product technical data label.

This product is designed to be permanently installed connected to a fixed facility. The towel rail power supply circuit must have an all-pole circuit breaker switch with a separation of at least 3mm between contacts.

The product should be installed, if at all possible, away from sources of draughts (windows, doors etc) or whichever other thing which may disturb the proper functioning of the product. In this way we can guarantee the maximum thermal comfort.

Place any item which may prevent the circulation of the air (sofas, furniture) at least 50cm away from the front of the product.

The product should not be installed in front of or immediately below a power point.

The lower part of the control panel must be situated at least 15cm from the floor.

As for any appliance, if the power cable is damaged it should be replaced by a specified cable. This cable should be changed by the manufacturer, its after-sales department or qualified personnel. The technical specifications of the product are shown on the technical data label.

IMPORTANT

- This product should never be installed with the control panel at the top.
- The vertically designed product should never be installed horizontally.
- Use wedges during the installation so that the control panel is not touching the floor.

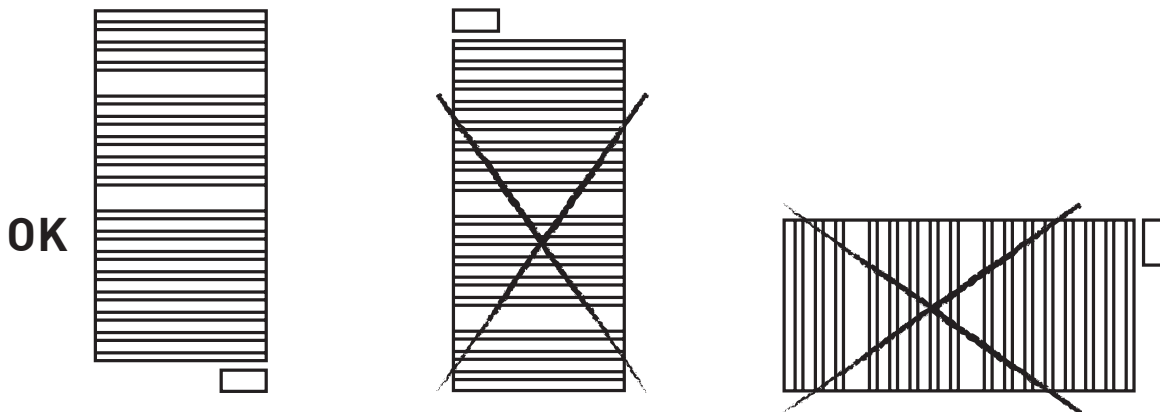

4.1 Specific Rules for bathrooms

This product conforms to the CLASS II (double insulation) safety regulations. A class II device identifies with the following icon:

Class II 

It can be installed in zones 2 & 3, positions A & B whenever it observes the following regulations:

- In the bathrooms, the radiator/towel rail must never be installed in such a way that the switches and control devices can be touched by someone in the bath or shower.
- In the bathrooms the towel rail must be placed at least 25cm from the floor.
- It must not be earthed

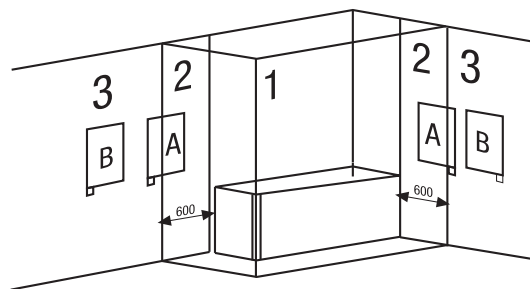

5. MAINTENANCE AND CLEANING

Thanks to the high standard of materials used and the quality of the surface treatment, the towel rail is protected against corrosion.

Don't use abrasive or corrosive products. Use a cloth with alcohol, taking care to switch off the product beforehand. Use a dry cloth (without solvents) to clean the control panel

5.1 Safety

This product is not designed for use by children under the age of 8, people with reduced physical, sensory or mental capacity or those

with no knowledge of the product unless they are supervised or trained in the safe use of the product or its dangers. Make sure children don't play with the product.

The cleaning and maintenance of the product can be carried out by children over 8 years old providing they are supervised.

Always make sure that the product and the cables are out of range of children under 8 years of age.

6. GUARANTEE

6.1. If you need to take advantage of the guarantee service please contact the wholesaler or installer where you purchased the product. In the event of any problems please contact Rointe Technical Support on 01432 598024 or by email to support@rointe.co.uk

6.2. ROINTE guarantees that this product doesn't have any defect in the material, design or manufacture at the time of purchase and guarantees the aluminium and leakages for the following 120 months and the electronics for 24 months.

6.3. If the towel rail does not work correctly due to defects in the design, faults in the materials or manufacture during this time then Rointe will repair or replace the towel rail whichever it considers more appropriate subject to the following conditions:

6.3.1. The guarantee will only be valid if the original guarantee which was issued by the seller to the buyer is presented. This guarantee must also state the serial number and model of the towel rail (this is found on the technical data label) and the date

of purchase. Rointe reserves the right to refuse the guarantee if this information has been removed or amended after the original purchase of the product.

Only the original invoice or receipt from the wholesaler or installer who sold the product will be acceptable as proof of purchase.

6.3.2. The guarantee will only be applicable to cases relating to defects in the material, design or manufacturing process and will not cover damages due to the following:

6.3.2.1. Incorrect use of the product for other than normal purposes or failure to follow Rointe's instructions regarding the use and maintenance of the towel rails. Also installation of the product in a way that fails to comply with the applicable technical safety standards.

6.3.2.2. Repairs carried out by unauthorised repairers or the opening of the towel rail by unauthorised persons.

6.3.2.3. Unforeseen circumstances which are beyond the control of Rointe such as lightning, fires, floods, public disorder, etc.

6.3.2.4. The repairs or replacements carried out under this guarantee do not allow an extension or a new guarantee period. Functionally equivalent reconditioned units will be used for the repairs or replacements covered under this guarantee. The pieces or defective components removed will become the property of Rointe.

6.3.2.5. This guarantee does not affect the buyer's statutory rights under the current national laws or the buyer's rights against the wholesaler or installer arising from the contract of sale.

6.3.2.6. In the event that there is no national legislation applicable, this guarantee will be the buyer's sole protection.

ROINTE, its offices, wholesalers and installers will not be held liable for whichever type of damages, whether fortuitous or accidental, caused by the breaking of whichever regulation related to this product.

European Community Directive (WEEE) 2012/19/EC 

Under the European Community Directive 2012/19/CE of waste electrical and electronic equipment (WEEE), these products cannot be disposed of in the usual council bins and containers. They have to be collected separately in order to optimize the recuperation and recycling of the materials and components and to reduce the impact to human health and the environment. The symbol of the crossed out wheelie bin with a single black line underneath appears on all of the Rointe products to remind the consumer to separate them for special collection. The consumer should contact the local authorities or the original seller to learn more about the correct disposal of their product.

| MODEL | POWER | VOLTAGE | HIGH (mm) | WIDTH (mm) | DEPTH (mm) | INST. DEPTH (mm) | WEIGHT |
|-----------|-------|---------|--------------|---------------|---------------|------------------------|--------|
| DTI030SEW | 300 W | 230 V~ | 843 | 500 | 55 | 100 | 13 kg |
| DTI030SEB | 300 W | 230 V~ | 843 | 500 | 55 | 100 | 13 kg |
| DTI030SEC | 300 W | 230 V~ | 843 | 500 | 55 | 100 | 13 kg |
| DTI045SEW | 450 W | 230 V~ | 1.161 | 500 | 55 | 100 | 17 kg |
| DTI045SEB | 450 W | 230 V~ | 1.161 | 500 | 55 | 100 | 17 kg |
| DTI045SEC | 300 W | 230 V~ | 1.161 | 500 | 55 | 100 | 17 kg |
| DTI060SEW | 600 W | 230 V~ | 1.475 | 500 | 55 | 100 | 21 kg |
| DTI060SEB | 600 W | 230 V~ | 1.475 | 500 | 55 | 100 | 21 kg |
| DTI060SEC | 450 W | 230 V~ | 1.475 | 500 | 55 | 100 | 21 kg |
| DTI075SEW | 750 W | 230 V~ | 1.797 | 500 | 55 | 100 | 25 kg |
| DTI075SEB | 750 W | 230 V~ | 1.797 | 500 | 55 | 100 | 25 kg |
| DTI075SEC | 600 W | 230 V~ | 1.797 | 500 | 55 | 100 | 25 kg |





Cortar por la línea de puntos

CERTIFICADO DE GARANTÍA



En el supuesto de defecto en el producto dentro del periodo de garantía, para hacer efectiva ésta, solicitamos rellene el certificado de garantía siguiente y nos lo remita sellado junto con copia de la factura de compra por correo electrónico a sat@rointe.com o a la siguiente dirección postal: INDUSTRIAS ROYAL TERMIC, S.L., C/E, Parcela 43, 30140 Santomera (Murcia).

Para obras de nueva construcción, será imprescindible para cubrir esta garantía la cédula de habitabilidad de la vivienda.

| CERTIFICADO DE GARANTÍA | |
|-------------------------|-------------------------------------|
| REFERENCIA: | Nº SERIE: |
| USUARIO: | |
| DOMICILIO: | |
| POBLACIÓN: | C.P. |
| PROVINCIA: | PAÍS: |
| TELÉFONO: | SELLO DEL ESTABLECIMIENTO VENDEDOR: |
| CORREO ELECTRÓNICO: | |
| | FECHA DE COMPRA: |

NOTA: Este certificado de garantía debe estar totalmente cumplimentado para tener derecho a la garantía, no debe faltar la fecha de compra ni el sello del establecimiento vendedor. Adjuntar copia de la factura de compra o copia de la cédula de habitabilidad para obra nueva.



ROINTE UK

Catalyst House
720 Centennial Court, Centennial Park
Elstree, Herts, WD6 3SY

Technical Support

T. 01432 598 024

Contact

T. 01432 598 019

F. 0208 953 5861

rointe@rointe.co.uk

www.rointe.co.uk



MDS15V1-UK