

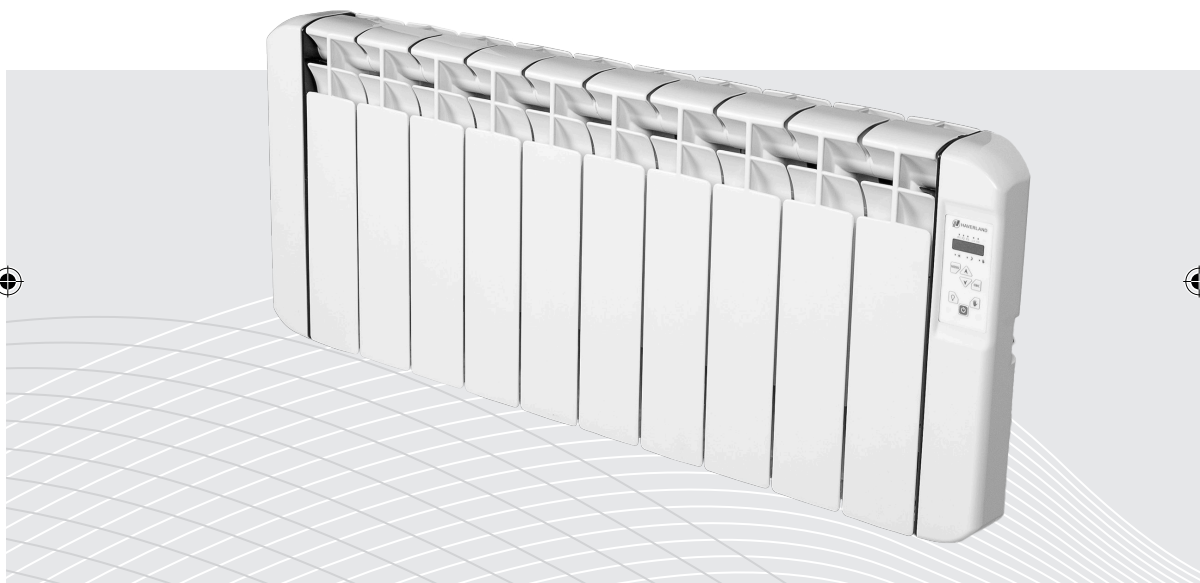

Manual de instalación y uso
Instructions & installation manual
Manuel d'installation et utilisation
Manual de instalação e uso

RCBL



Español

English

Français

Português



www.haverland.com
www.haverland.co.uk

RCBL_V2_16March2018_MISA_ESUKFP2018



**ES****ÍNDICE**

4	1. ADVERTENCIAS GENERALES
6	2. INSTALACIÓN
9	3. FUNCIONAMIENTO
9	3.1 PANEL DE CONTROL
9	3.2 INICIO - PRIMERA CONEXIÓN
10	3.3 MODO ANTIHIELO
10	3.4 MODOS DE CALEFACCIÓN
11	3.5 MODO MANUAL
12	3.6 CONFIGURACIÓN DEL TERMOSTATO
14	3.7 AJUSTE DEL RELOJ
14	3.8 AJUSTE DÍA DE LA SEMANA
15	3.9 AJUSTE TEMPERATURA CONFORT
15	3.10 AJUSTE TEMPERATURA DE ECONOMÍA
16	3.11 PLANES HORARIOS
19	3.12 FUNCIÓN INDICADOR CONSUMO"
19	3.13 FUNCIÓN AHORRO "VENTANAS ABIERTAS"
20	3.14 FUNCIÓN INTELIGENTE ITCS
21	3.15 APAGAR EL DISPLAY
22	3.16 BLOQUEO DE TECLADO
22	3.17 FUNCIÓN "BOOST" - FUNCIÓN 2 HORAS
23	3.18 CAMBIO DE IDIOMA
23	3.19 DESCONEXIÓN RED ELÉCTRICA / CORTE SUMINISTRO
23	4. MANTENIMIENTO

EN**INDEX**

24	1. CAUTION
26	2. INSTRUCTIONS FOR INSTALLATION
29	3. OPERATION
29	3.1 CONTROL PANEL
29	3.2 START - FIRST CONNECTION
30	3.3 ANTI-FREEZE MODE
30	3.4 HEATING MODES
31	3.5 MANUAL MODE
32	3.6 SETTING THE THERMOSTAT
34	3.7 SETTING THE CLOCK
34	3.8 SETTING THE DAY OF THE WEEK
35	3.9 SETTING THE COMFORT TEMPERATURE
35	3.10 SETTING THE ECONOMY TEMPERATURE
36	3.11 TIME SCHEDULES
39	3.12 CONSUMPTION INDICATOR FUNCTION
39	3.13 "OPEN WINDOWS" FUNCTION
40	3.14 INTELLIGENT ITCS FUNCTION
41	3.15 SWITCH OFF THE DISPLAY
42	3.16 KEYBOARD LOCK
42	3.17 2 HOUR BOOST FEATURE
43	3.18 CHANGING THE LANGUAGE
43	3.19 DISCONNECTION FROM THE MAINS / POWER CUT
43	4. MAINTENANCE



**FR****INDEX**

44	1. AVERTISSEMENTS GÉNÉRAUX
46	2. INSTRUCTIONS D'INSTALLATION
49	3. FONCTIONNEMENT
49	3.1 PANNEAU DE COMMANDE
49	3.2 DÉMARRAGE : PREMIÈRE CONNEXION
50	3.3 MODE HORS-GEL
50	3.4 MODES DE CHAUFFAGE
51	3.5 MODE MANUEL
52	3.6 CONFIGURATION DU THERMOSTAT
54	3.7 RÉGLAGE DE L'HEURE
54	3.8 RÉGLAGE DU JOUR DE LA SEMAINE
55	3.9 RÉGLAGE DE LA TEMPÉRATURE CONFORT
55	3.10 RÉGLAGE TEMPÉRATURE D'ÉCONOMIE
56	3.11 PLANS HORAIRES
59	3.12 FONCTION INDICATEUR DE CONSOMMATION
59	3.13 FONCTION ÉCONOMIE " FENÊTRE OUVERTE "
60	3.14 FONCTION INTELLIGENTE ITCS
61	3.15 ÉTEINDRE LE DISPLAY
62	3.16 VERROUILLAGE DE CLAVIER
62	3.17 FONCTION " BOOST " - FONCTION 2 HEURES
63	3.18 MODIFICATION DE LA LANGUE
63	3.19 DÉCONNEXION DU RÉSEAU ÉLECTRIQUE / COUPURE
63	4. ENTRETIEN

P**ÍNDICE**

64	1. AVERTÊNCIAS GERAIS
66	2. INSTRUÇÕES DE INSTALAÇÃO
69	3. FUNCIONAMENTO
69	3.1 PAINEL DE CONTROLE
69	3.2 INÍCIO - PRIMERA LIGAÇÃO
70	3.3 MODO ANTI-GELO
70	3.4 MODOS DE AQUECIMENTO
71	3.5 MODO MANUAL
72	3.6 CONFIGURAÇÃO DO TERMOSTATO
74	3.7 ACERTO DO RELÓGIO
74	3.8 ACERTO DO DIA DA SEMANA
75	3.9 AJUSTE DA TEMPERATURA CONFORTO
75	3.10 AJUSTE DE TEMPERATURA DE ECONOMIA
76	3.11 PROGRAMAS HORÁRIOS
79	3.12 FUNÇÃO INDICADOR CONSUMO
79	3.13 FUNÇÃO DE POUPANÇA " JANELAS ABERTAS "
80	3.14 FUNÇÃO INTELLIGENTE ITCS
81	3.15 DESLIGAR O DISPLAY
82	3.16 BLOQUEIO DO TECLADO
82	3.17 FUNÇÃO "BOOST" - FUNÇÃO 2 HORAS
83	3.18 MUDANÇA DE IDIOMA
83	3.19 DESCONEXÃO DA REDE / CORTE DO ABASTECIMENTO
83	4. MANUTENÇÃO

ES**EN****FR****P**



ES

1. ADVERTENCIAS GENERALES

- **Por favor, lea estas instrucciones detenidamente.**
- Para desconectar el emisor de la red eléctrica saque la clavija de alimentación del enchufe. **Nunca tire del cable.**
- No dejar el cable de conexión en contacto con el aparato mientras esté encendido.
- **La garantía del aparato no cubrirá cualquier daño causado por la no lectura de estas instrucciones.**



PELIGRO: NO CUBRIR EL APARATO. NO LO USE PARA SECAR ROPA. Si se cubre, existe el riesgo de producirse un sobrecalentamiento.



• **PELIGRO: Si el cable de alimentación está dañado, debe ser sustituido por el fabricante, por su Servicio Postventa o por personal cualificado similar.**



• **PELIGRO: Si el aparato se va a instalar en un cuarto de baño, debe ser instalado de tal manera que no pueda ser tocado por cualquier persona que se encuentre en la bañera o ducha.**



• **La instalación debe ser efectuada teniendo en cuenta estas instrucciones y acorde a la legislación eléctrica vigente.**

- El aparato no debe estar situado debajo o delante de una toma de corriente.
- La instalación debe ser efectuada según la legislación eléctrica vigente.
- Este aparato debe ser conectado a tierra.
- El emisor debe ser instalado de tal manera que la clavija de alimentación sea siempre accesible.

• **Este emisor térmico es un aparato para fijarlo a la pared. Este emisor no se debe encastrar. Respetar siempre las distancias de seguridad.**

• **Para evitar que los niños puedan variar la programación del emisor, dispone de un bloqueo.**

• Durante su funcionamiento, debe tenerse la precaución de mantener el aparato alejado de materiales combustibles tales como cortinas, moquetas, muebles, etc.

• Este aparato no está pensado para ser usado por personas (incluidos niños) con capacidades físicas reducidas, sensoriales o mentales, con poca experiencia o conocimiento, al menos que estén bajo supervisión de una persona responsable de su seguridad con las instrucciones de uso del aparato. Los niños deben ser supervisados para asegurar que no juegan con el aparato.

• Los niños menores de 3 años deben mantenerse fuera del alcance del





1. ADVERTENCIAS GENERALES

ES

aparato a menos que sean continuamente supervisados. Los niños desde 3 años y menores de 8 años deben sólo encender/apagar el aparato siempre que éste haya sido colocado o instalado en su posición de funcionamiento normal prevista y que sean supervisados o hayan recibido instrucciones relativas al uso del aparato de una forma segura y entiendan los riesgos que el aparato tiene.

- Los niños desde 3 años y menores de 8 años no deben enchufar, regular y limpiar el aparato o realizar operaciones de mantenimiento.

- Este aparato puede ser usado por niños mayores de 8 años y por personas con discapacidades físicas, sensoriales o mentales, o sin experiencia o conocimientos, siempre y cuando hayan sido debidamente formados y sean supervisados por alguien que entienda los riesgos.

- La limpieza y el mantenimiento a realizar por el usuario no se deben hacer por niños. Los niños no deben jugar con el aparato.



- **PRECAUCIÓN: Algunas partes de este producto pueden ponerse muy calientes y causar quemaduras.** Debe ponerse atención particular cuando los niños y las personas vulnerables estén presentes.

- No tocar las partes externas del emisor cuando esté en funcionamiento.

- Antes del primer arranque o antes del comienzo de la campaña de invierno o cuando el emisor no se ha usado durante muchos días, el aparato debe ser limpiado (siga los pasos del punto “mantenimiento” de este manual.

- Es normal que en las primeras puestas en marcha, el aparato produzca olores. Ponga en marcha el aparato en un lugar ventilado durante 2 ó 3 horas.



- **PRECAUCIÓN:** Para evitar riesgos de asfixia, no dejar las bolsas y demas accesorios al alcance de bebes y niños.

- Este emisor **NO puede funcionar** con centralitas externas programables o cualquier otro dispositivo de control exterior.

- El efecto de la convención, junto a otros factores ambientales, puede causar **decoloración en las superficies metálicas y en los plásticos.**

- Los contrastes de temperatura pueden generar “chasquidos” o ruidos en el aparato. Esto no es un fallo del emisor, sino que se debe a la dilatación/contracción del aluminio.

- Este emisor se ha llenado con una cantidad determinada de un fluido térmico especial, por lo que las reparaciones que requieran la apertura del depósito o la presencia de fugas, no deben efectuarse más que por el fabricante o por un S.A.T. Oficial.

- Cuando se desechen los emisores, deben tenerse en cuenta los requisitos establecidos por la legislación para el tratamiento y reciclaje de los residuos (fluido térmico).

ES





ES

2. INSTALACIÓN



IMPORTANTE

- Es indispensable que el emisor **SE FIJE FIRMEMENTE A UNA PARED ESTABLE Y NIVELADA.**
- Comprobar que exista un enchufe cerca de donde lo vaya a situar.
- Saque del interior de la caja de embalaje la plantilla donde se indica la posición de los taladros para colocar el aparato a la pared.
- Para evitar problemas es necesaria una distancia mínima de 15 cm entre el emisor y cualquier material.

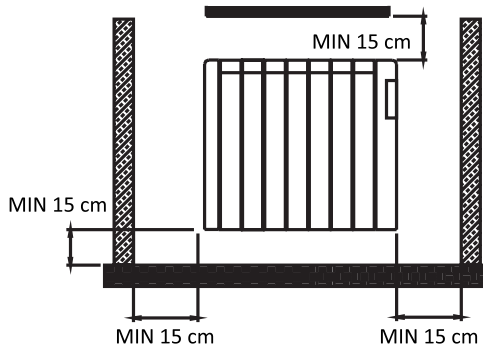



2. INSTALACIÓN

ES

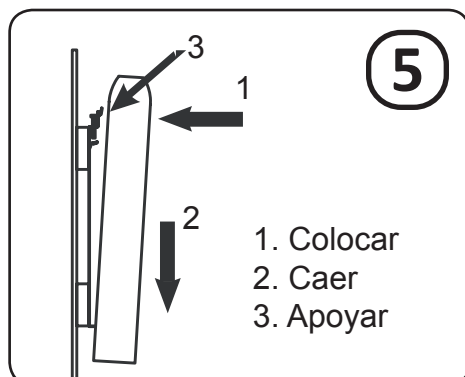
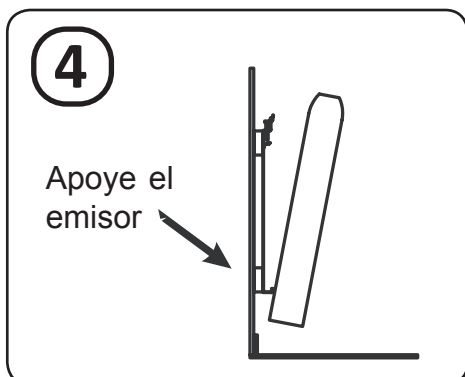
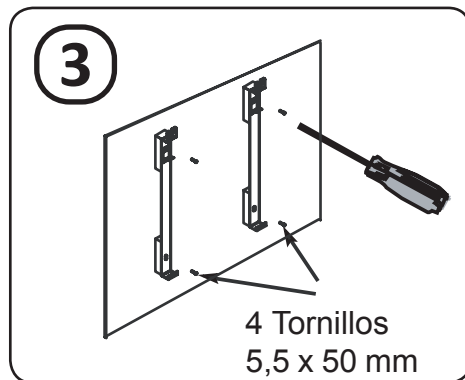
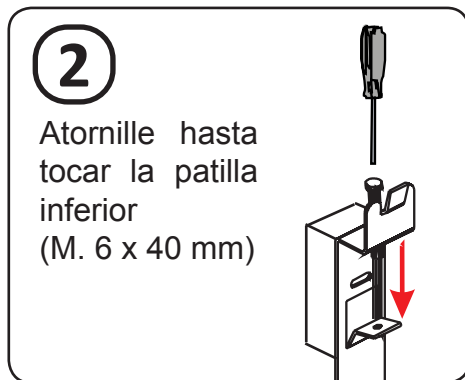
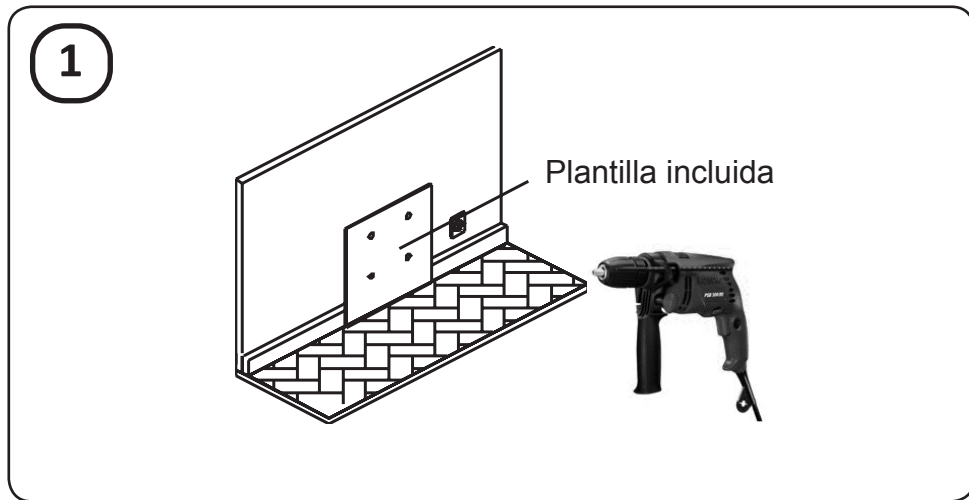

ES

RCBL ▶ 7





ES

2. INSTALACIÓN

6



IMPORTANTE:

Atornille completamente para fijar el emisor

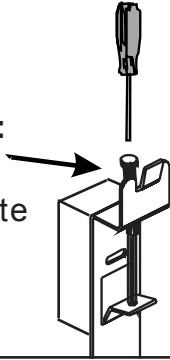

7

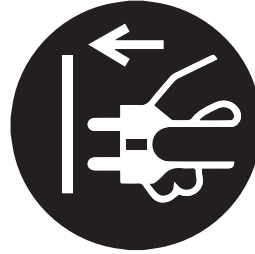

8

Pulsar el interruptor situado en el lateral derecho



INFORMACIÓN

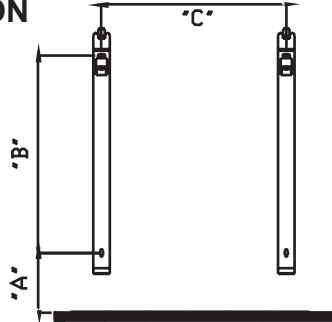

(W)	"A" (mm)	"B" (mm)	"C" (mm)
1000	320	132	560
1250	320	132	560
1500	320	132	885



3. FUNCIONAMIENTO

ES

3.1 PANEL DE CONTROL

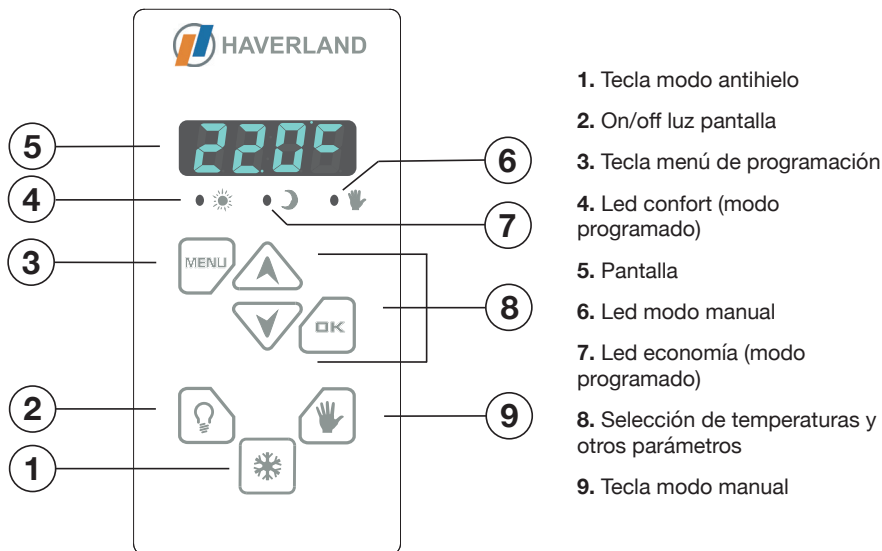

3.2 INICIO - PRIMERA CONEXIÓN

En el momento que se conecta el emisor a la red eléctrica y pulsa el interruptor:

1. Si es la primera vez aparece parpadeando en la pantalla **"Pr:Hd"**.
2. Pulsar tecla  . A continuación, se mostrará la temperatura de ambiente.

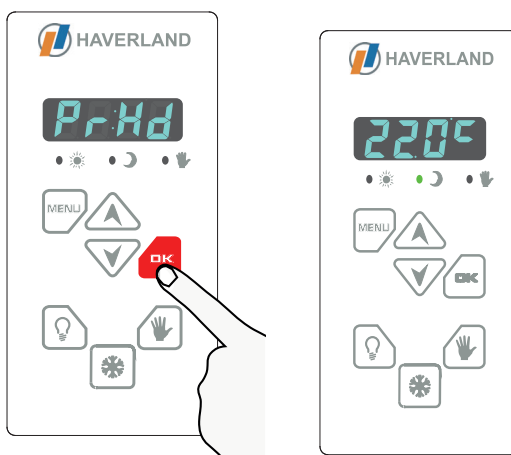

ES

RCBL ► 9



ES

3. FUNCIONAMIENTO

3.3 MODO ANTIHIELO

Pulsando la tecla , el emisor cambia de modo “antihielo” a “modo calefacción” y viceversa.

En la pantalla aparecerá la temperatura ambiente.



Para indicar “modo antihielo” el led economía (luna) parpadeará cada 5 segundos aproximadamente.

Modo Antihielo

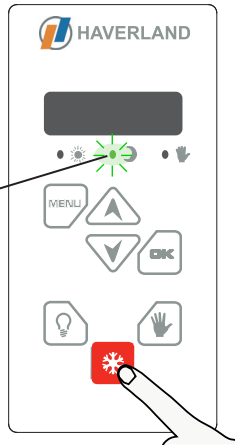

Parpadeo cada 5 seg.

Modo Calefacción



Recuerde que puede pasar a “modo antihielo” pulsando la tecla . Gracias a este **modo “antihielo”** evitará las temperaturas extremas en su vivienda, manteniendo la temperatura ambiente en **7°C**.

3.4 MODOS DE CALEFACCIÓN

En modo calefacción, el emisor tiene dos modos de funcionamiento, modo **PROGRAMADO** o **MANUAL**.

Elija el modo de funcionamiento pulsando la tecla .

Modo Programado

Led Mano apagado 

Modo Manual

Led Mano encendido 



3. FUNCIONAMIENTO

ES

Modo Programado

En modo programado, el emisor puede estar en ciclo de confort, de economía o antihielo.

-  Led Confort
-  Led Economía
-  Led Economía parpadeando: antihielo

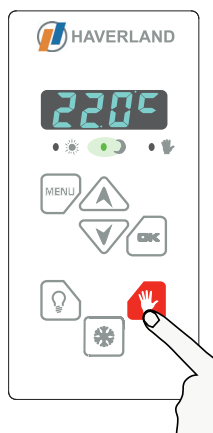

Modo Manual

Led mano encendida



 Los leds confort (sol) y economía (luna) estarán apagados.



Recuerde que puede pasar a “modo” antihielo pulsando la tecla 





Para un uso eficiente de su emisor recomendamos usar el modo programado. Programe su emisor con las horas concretas que necesite de calefacción en la estancia.



3.5 MODO MANUAL



En modo manual, el emisor funciona como un termostato de ambiente.

Una vez elegido el modo manual (led mano encendido) pulse la tecla  o  para definir la temperatura de consigna deseada.

Pasados unos segundos se regresa a la pantalla principal indicando la temperatura de ambiente de la estancia.

En cualquier momento puede visualizar la temperatura de consigna elegida pulsando la tecla  o .



Un punto azul luminoso parpadeará en el lado derecho de la pantalla cuando el emisor esté calentando.

ES

RCBL ► 11



ES

3. FUNCIONAMIENTO

3.6 CONFIGURACIÓN DEL TERMOSTATO

Para acceder al menú de configuración, **pulse la tecla**  **durante 2 seg.** De esta manera se entra en el menú de opciones.

Pulsando sucesivamente la tecla  podrá acceder a los submenús que quiera ajustar.

Las opciones del menú de configuración se muestran en el siguiente esquema:

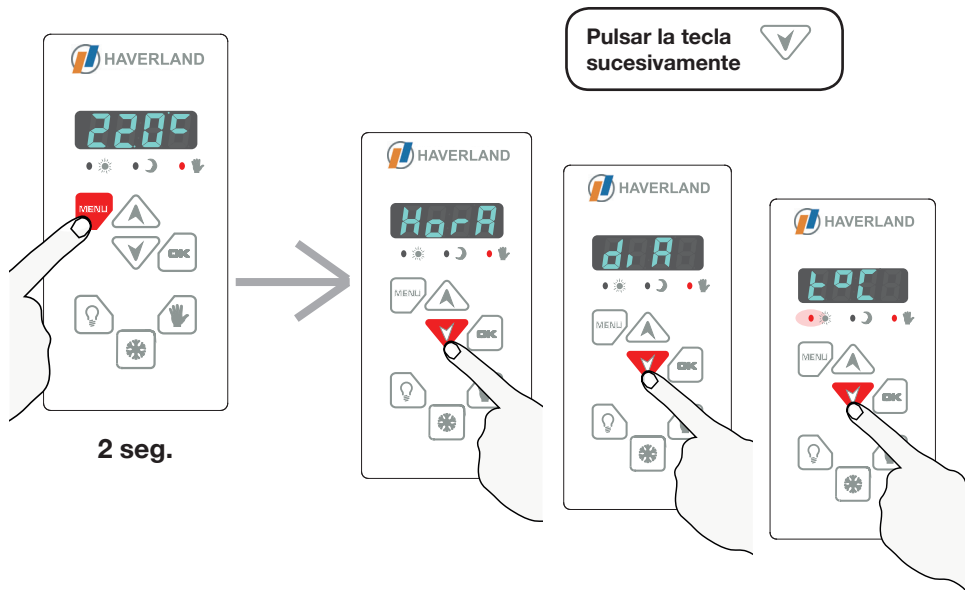



3. FUNCIONAMIENTO

ES



ES



Para salir del menú de configuración presione la tecla



3.7 AJUSTE DEL RELOJ

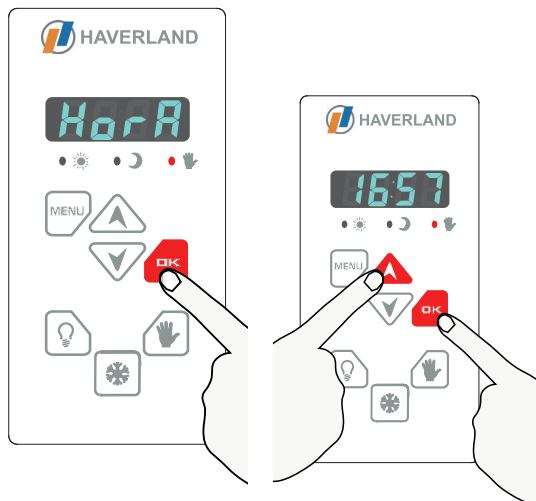

En el submenú “**HorA**”, puede configurar la hora y minutos actuales.

Pulse . Los dos primeros dígitos parpadearán. Ajuste la hora actual mediante las teclas y .

Pulse . Parpadearán los minutos. Siga el mismo procedimiento mediante las flechas para ajustarlos.

Finalice pulsando la tecla . Pasará al submenú de ajuste siguiente.



Para salir del menú de configuración presione



3.8 AJUSTE DÍA DE LA SEMANA

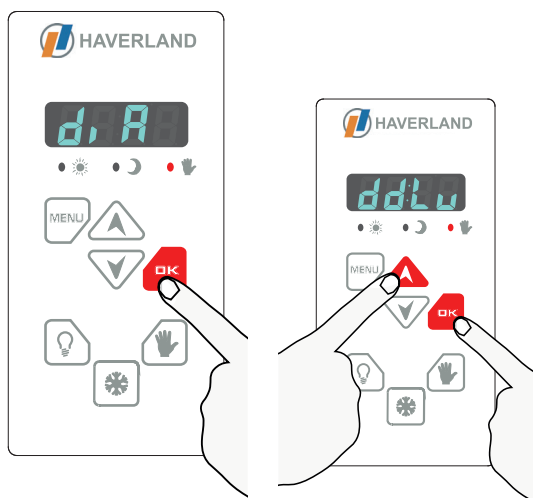

Pulse . Parpadeará el día de la semana.

Con las teclas y ajuste el día de la semana actual.

Finalice pulsando la tecla . Pasará al submenú de ajuste siguiente.

3. FUNCIONAMIENTO

ES

3.9 AJUSTE TEMPERATURA CONFORT

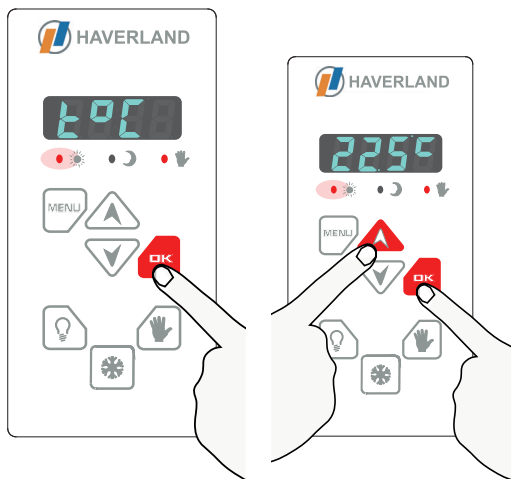

En este submenú puede ajustar la temperatura de confort deseada para los ciclos de confort.

El ajuste se podrá realizar entre un mínimo de 5 °C y un máximo de 32 °C, en tramos de 0,5 °C, teniendo en cuenta que esta temperatura no podrá ser inferior a la temperatura economía seleccionada a continuación.

El ajuste se realiza mediante las teclas



Finalice pulsando la tecla . Pasará al submenú de ajuste siguiente.



Temperatura de confort recomendada 21 °C

3.10 AJUSTE TEMPERATURA DE ECONOMÍA

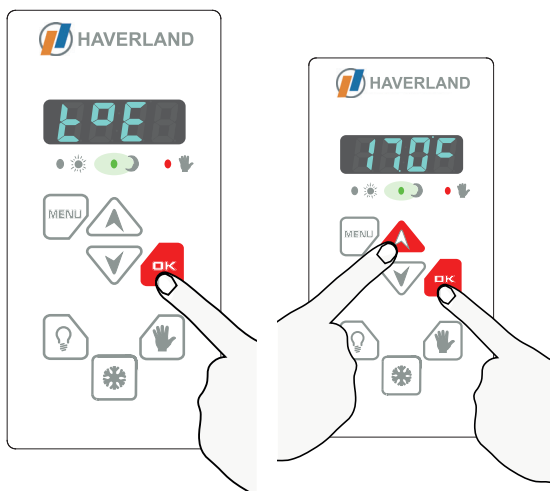

En este submenú puede ajustar la temperatura de economía deseada para los ciclos de economía.

El ajuste se podrá realizar entre un mínimo de 5 °C y un máximo de 32 °C, teniendo en cuenta que esta temperatura no podrá ser superior a la temperatura de confort elegida.

Finalice pulsando la tecla . Pasará al submenú de ajuste siguiente.



Temperatura de economía recomendada 17 °C

ES



ES

3. FUNCIONAMIENTO

3.11 PLANES HORARIOS

El emisor térmico dispone de **4 planes horarios programados de serie**, configurados desde fábrica, y un **plan horario configurable**, modificable por el usuario.

Estos 4 planes horarios de fábrica **no modificables** están adecuados a la mayoría de las situaciones de calefacción que pueda necesitar.

En este submenú puede elegir uno de los 4 planes horarios de fábrica o el plan configurable.

- PL01:** - Confort de lunes a domingo de 10 a 00 h. El resto de horas, economía.
- PL02:** - Confort de lunes a viernes de 7 a 9 h, de 12 a 16 h y de 18 a 00 h. El resto de horas, economía.
- Confort de sábado a domingo de 10 a 00 h. El resto de horas, economía.
- PL03:** - Confort de lunes a viernes de 6 a 9 h y de 16 a 00 h. El resto de horas, economía.
- Confort de sábado a domingo de 10 a 00 h. El resto de horas, economía.
- PL04:** - Confort de lunes a viernes de 6 a 9 h y de 19 a 00 h. El resto de horas, economía.
- Confort de sábado a domingo de 9 a 11 h, de 14 a 16 h y de 20 a 00 h. El resto de horas, economía.

El plan configurable "PLCF" es modificable. Por defecto, está configurado de fábrica de la siguiente manera:

- PLCF:** - Confort de lunes a viernes de 7 de 14 h y de 15 a 19 h. El resto de horas, economía.



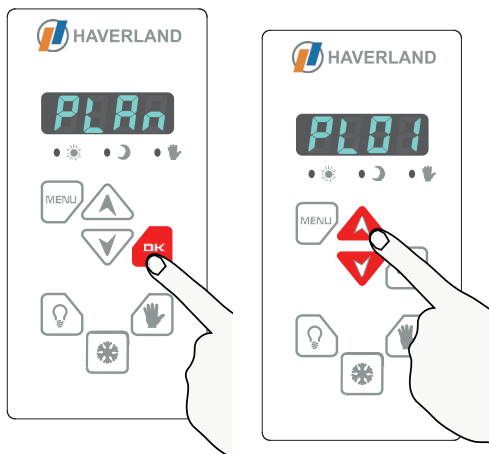

Los ciclos de confort y de economía, tendrán en cuenta las temperaturas de confort y de economía predefinidas en los pasos anteriores (puntos 3.9 y 3.10).

Planes horarios predefinidos de serie PL01, PL02, PL03 y PL04:



Una vez aparezca la palabra **"PLAN"** en el submenú, pulse  para entrar en el submenú de planes horarios.

Aparecerá el plan **"PL01"** en la pantalla.

A continuación, pulse las teclas  o  para elegir el plan horario deseado.

Elija uno de los 4 planes horarios de fábrica, por ejemplo **"PL02"**.



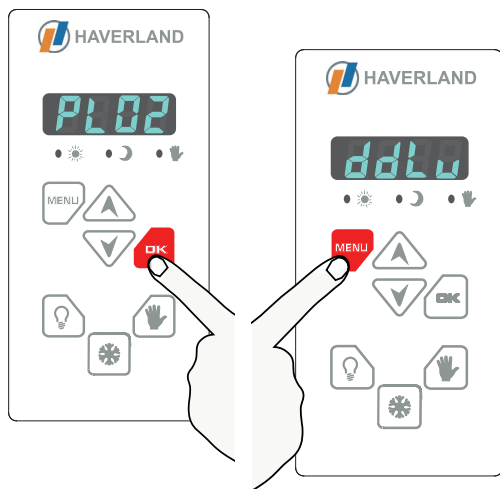

3. FUNCIONAMIENTO

ES



Pulse a continuación la tecla  para confirmar el plan horario elegido (aparecerá en pantalla ddLu”).

 A continuación, si lo desea, puede comprobar el plan horario elegido pulsando sucesivamente la tecla .

Para validar el plan elegido y finalizar el proceso de configuración, pulse la tecla .

 Un punto azul luminoso parpadeará en el lado derecho de la pantalla cuando el emisor esté calentando.

 El emisor sigue el plan horario elegido de acuerdo con las temperaturas de confort y de economía elegidas en los puntos 3.9 y 3.10 de este manual.

Plan horario configurable PLCF:

En el plan modificable “PLCF” puede realizar un programa a su medida, día a día, hora a hora.

En el submenú “PLAn” y una vez elegido el plan configurable “PLCF”, pulse .

Aparecerá “ddLu” en la pantalla. A continuación, pulse  para continuar.

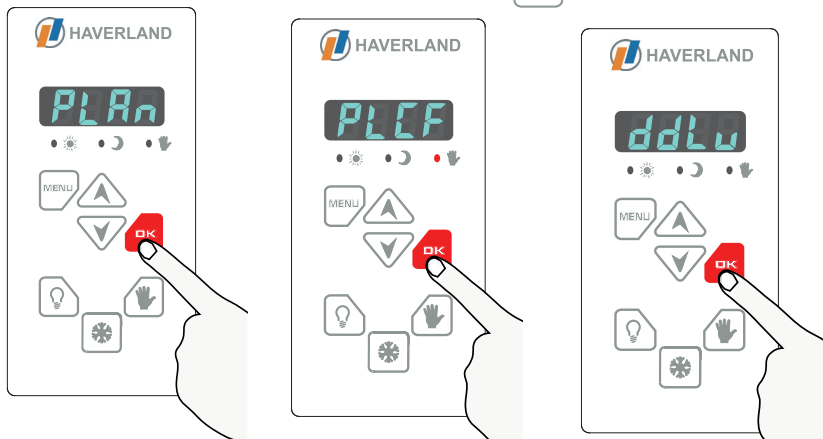





ES

RCBL ► 17

En la pantalla indicará "00:00". Con las teclas  o  elija el ciclo de funcionamiento, confort, economía o antihielo, para la primera franja horaria (de 00:00h a 01:00h):



Ciclo Confort = Led sol encendido 
 Ciclo Economía = Led luna encendido 
 Ciclo Antihielo = Led verde parpadeando 

 La temperatura antihielo está definida a 7 °C.



Pulse  para pasar a la franja horaria siguiente (de 01:00 h a 02:00 h) y repita el proceso anterior para elegir el ciclo de funcionamiento deseado (confort, economía o antihielo). Repita el proceso hora a hora, día a día.



Una vez configurado el plan horario de toda la semana, el emisor obedecerá a este plan siempre y cuando el modo de funcionamiento elegido sea el **modo PROGRAMADO** (comprobar que el led "mano" esté apagado).

 Un punto azul luminoso parpadeará en el lado derecho de la pantalla cuando el emisor esté calentando.

 En el plan "PLCF" el emisor sigue el plan horario definido por el usuario según sus necesidades y de acuerdo con los ciclos de confort, economía o antihielo indicados.

 Para modificar el ciclo de funcionamiento en una/s de la/s franja/s horaria/s, repita los pasos indicados anteriormente. Una vez modificado su plan configurable, salga del menú programación pulsando varias veces la tecla  hasta que vuelva a mostrarse la temperatura en la pantalla.



3. FUNCIONAMIENTO

ES

3.12 FUNCIÓN INDICADOR CONSUMO

El emisor incorpora una **función única en el mercado** que le permite conocer su consumo eléctrico.

Una vez posicionado en el submenú "WAT", pulse  para entrar en esta función.

El contador de energía le indicará el sumatorio de los KW/h acumulados cada 24 horas desde el último reinicio. Este contador se reinicia cada 30 días naturales. También puede ser reiniciado en cualquier momento pulsando la tecla  durante 2 segundos.

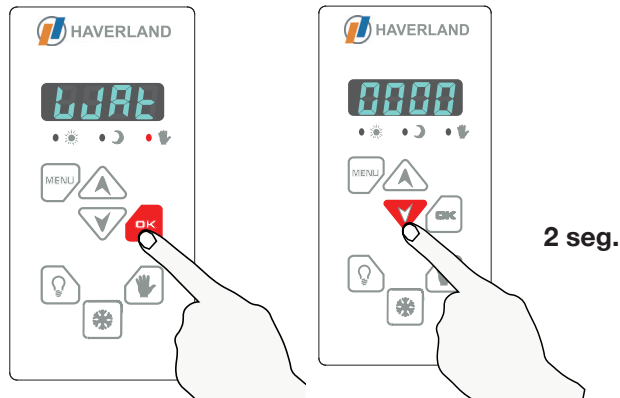

3.13 FUNCIÓN AHORRO "VENTANAS ABIERTAS"

Esta función se activa cuando se produce un descenso brusco de la temperatura en la habitación.



Al activarse esta función, aparece parpadeando el led verde "luna" y parpadeando "VEN" en pantalla. El emisor se desconectará evitando un consumo de energía innecesario.



ES

Al cerrar la ventana, el emisor detectará una subida de temperatura y se desactivará esta función.

El emisor se encenderá de nuevo volviendo al estado anterior a la desconexión.





Esta función puede ser activada o desactivada por el usuario. Una vez posicionado en el submenú "VEn", pulse para entrar en esta función.

A continuación, pulse las teclas o para elegir "On" u "OFF" para activar o desactivar esta función.

A continuación, pulse para validar. Pulse para salir del menú.

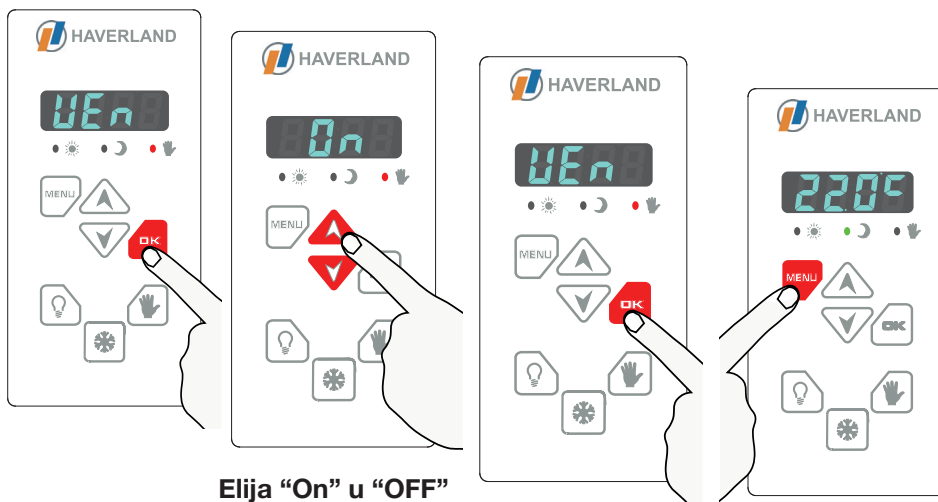

3.14 FUNCIÓN INTELIGENTE ITCS

El emisor incorpora un **innovador sistema de control inteligente de temperatura ITCS**.

Este sistema activa la puesta en marcha del emisor con **antelación a la hora programada** (2 horas máximo), para asegurar que se consigue la temperatura deseada a la hora indicada y siguiendo el programa semanal establecido.

Esta función inteligente está activada de serie. Puede ser desactivada por el usuario.



Esta función puede ser activada o desactivada por el usuario. Una vez posicionado en el submenú "Itcs", pulse para entrar en esta función.

A continuación, pulse las teclas o para elegir "On" u "OFF" para activar o desactivar esta función.

A continuación, pulse para validar. Pulse para salir del menú.

3. FUNCIONAMIENTO

ES

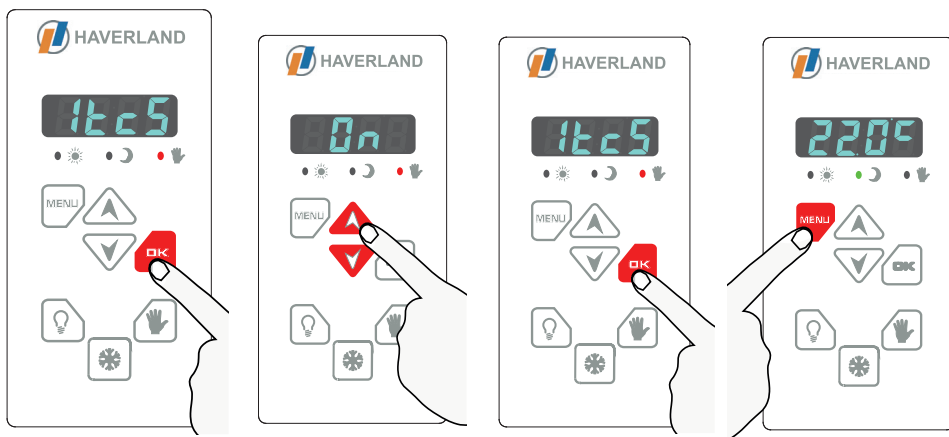

Elija "On" u "OFF"



Los segmentos de la C girarán cuando se esté ejecutando la función ltcS.



3.15 APAGAR EL DISPLAY

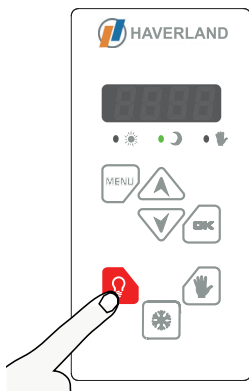

Para apagar la pantalla pulse la tecla .

Presione de nuevo la tecla  para volver a mostrar la pantalla.

ES



Los leds sol, luna o manual permanecerán encendidos. Un punto azul luminoso parpadeará en el lado derecho de la pantalla si el emisor está calentando.



ES

3. FUNCIONAMIENTO

3.16 BLOQUEO DE TECLADO

Presione simultáneamente las teclas  y  hasta que aparezca en la pantalla la palabra **Loc**.

Debe realizar la misma operación para desbloquear el teclado. En la pantalla aparecerá la palabra **unlo**.

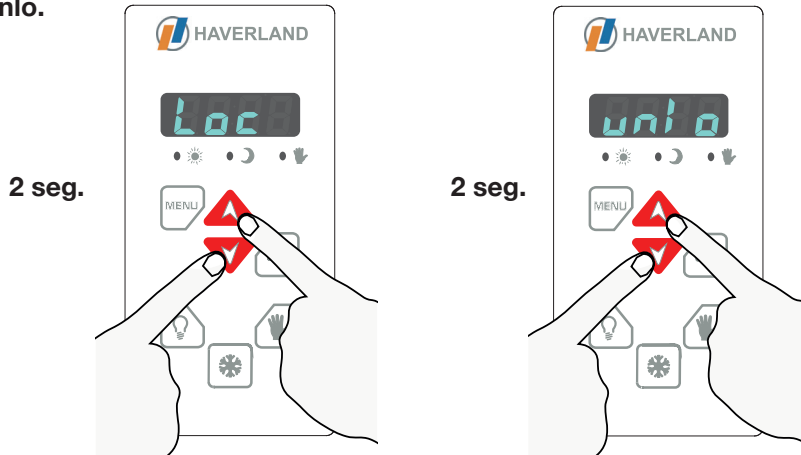

3.17 FUNCIÓN “BOOST” - FUNCIÓN 2 HORAS

Esta función pone el aparato en funcionamiento a máxima potencia durante dos horas, independientemente del modo de funcionamiento que esté seleccionado. Esta función tiene prioridad sobre cualquier otra.

Para activar esta función pulse la tecla  durante **10 segundos** hasta que aparezca “booS” en pantalla.

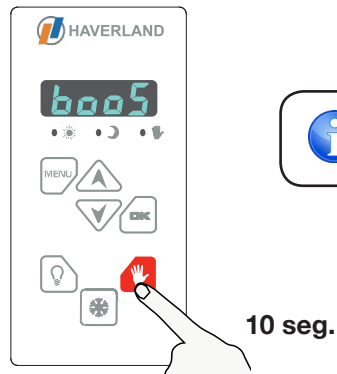

Al activarse esta función, aparece “booS” en pantalla.

Puede desactivar la función “Boost” antes de finalizar las 2 horas, pulsando la tecla  o la tecla



22 ► RCBL





4. OTROS

ES

3.18 CAMBIO DE IDIOMA

El menú del emisor puede configurarse en varios idiomas (español, inglés o francés).

Entre en el menú de configuración pulsando la tecla  durante 2 segundos.

Pulse la tecla  para cambiar de un idioma a otro.

Cuando elija el idioma deseado, pulse la tecla .

Pulse la tecla  para salir de menú configuración.

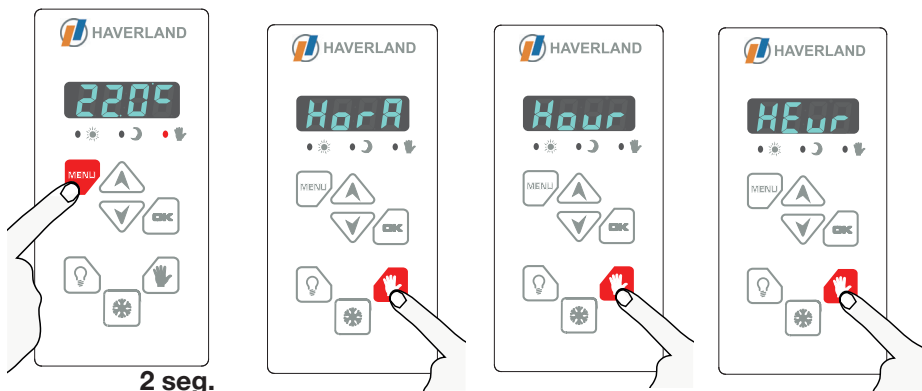

3.19 DESCONEXIÓN RED ELÉCTRICA / CORTE SUMINISTRO



Si el emisor se mantiene desconectado de la red eléctrica (por ejemplo, interruptor del emisor desconectado) o si se produce un corte del suministro eléctrico superior a 24 horas, aparecerá en la pantalla parpadeando "Pr:Hd".

Debe editar la hora y el día siguiendo el punto 3.2 del manual "INICIO - PRIMERA CONEXIÓN".

El resto de los parámetros programados se mantienen en memoria.

ES

4. MANTENIMIENTO

Su emisor térmico no precisa de ningún tipo de mantenimiento especial.

Solamente limpie el polvo que se pueda acumular con un trapo seco y suave.

Es conveniente al comenzar la temporada de invierno, limpiar el polvo acumulado sobre la superficie del emisor.



NUNCA UTILICE DISOLVENTES NI PRODUCTOS ABRASIVOS.





EN

1. CAUTION

- **Please read these instructions carefully.**
- To disconnect mains power from the radiator remove the plug from the wall socket, but never pull on the cable.
- Do not leave the mains cable in contact with the radiator when it is switched on.
- During operation, the radiator must be kept well away from combustible materials, such as curtains, carpets and furniture etc.
- **The warranty for the radiator does not cover any damage caused by not reading these instructions.**



WARNING: In order to avoid overheating, do not cover the heater.



• **WARNING:** If the mains power cable is damaged, it must be replaced by the manufacturer, with their after-sales service or similar qualified persons, in order to prevent any danger.



• **WARNING:** If the heater is to be installed in a bathroom, it must be positioned so that it cannot be touched by anybody in the bath or shower.



• **The installation should be carried out with consideration to the manufacturer's instructions and in accordance to the relevant National Wiring Regulations BS7671.**

- It is very important that radiator has a good Electric Earth connection.
- The radiator shall be installed so that its mains plug is always accessible.
- The radiator must not be installed below or in front of a mains socket.
- **This radiator cannot be surface-mounted with a wall. Safety distances shall always be respected.**
- **The radiator has a keyboard blockage option to prevent children from changing the programming.**
- This unit is not designed to be handled by persons (including children) with physical, sensorial or mental handicaps, with little experience or knowledge unless they are under the supervision of an adult responsible for their safety with the instructions on its use. Children shall always be supervised to ensure they do not play with the unit.
- Children under three shall be kept well away from the heater unless they are continually supervised.
- Children between three and eight shall only switch the unit off or on providing it is positioned or installed in its final operating location and be supervised or have received instructions on how to use the unit in a safe manner and understand the risks involved.
- Children between three and eight shall not plug in, adjust or clean the heater or carry out any maintenance operations.
- This unit may be used by children older than eight and by persons with physical, sensorial or mental handicaps, with little experience or knowledge, provided they have been duly trained and are supervised by an adult that understands the risks involved.
- Cleaning and maintenance shall be performed by adults not children. Children must not play with the unit.
- **WARNING:** Certain parts of this product can become very hot and





1. CAUTION

EN

cause burns. Special attention shall be paid when children and other vulnerable persons are present.

- Do not touch the external parts of the radiator when it is operating.
- It is quite normal that, with the first switch-on, the unit produces a “new” smell. Allow your heater to operate in a well-ventilated place for two or three hours.
- Before the first switch on for the coming winter or when the heater has not been used for several days, the unit should be cleaned (follow the steps given in the “maintenance section”). This cleaning operation will avoid burning the accumulated dust and other remains.
- This radiator **CAN'T OPERATE** with external programmable controllers or any other exterior control device.
- **CAUTION:** Keep bags and other accessories well out of the reach of children.
- The convection effect, together with other ambient factors, can cause discolouring to metal surfaces and to plastics.
- Temperature differences can cause crackling and other noises in the unit. This does not indicate any failure in the radiator.
- This radiator is filled with a precise amount of special oil that does not need any maintenance.
- The regulations on discarding oil when the heater is being disposed of must be observed.
- When the radiator is disposed of, the requirements established by current legislation on waste processing and recycling shall be taken into account.



EN





EN

2. INSTRUCTIONS FOR INSTALLATION



IMPORTANT

- It is important that the radiator **IS FIXED FIRMLY TO A SOLID AND LEVELLED WALL.**
- Make sure that there is a socket near the area where you are going to place it.
- Take out the wall pattern from the box to see the exact positions of the necessary drill holes.
- You must keep a minimum distance of 15 cm between the radiator and any object, wall or combustible material.

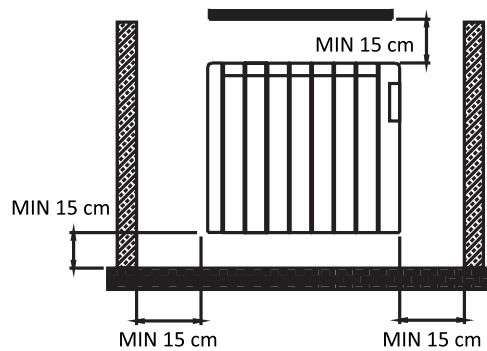



2. INSTRUCTIONS FOR INSTALLATION

EN

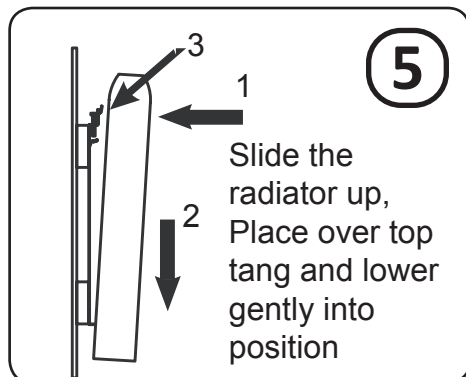
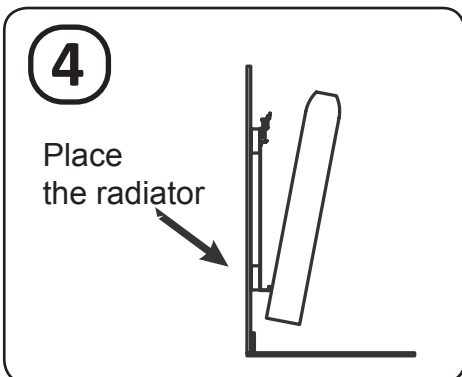
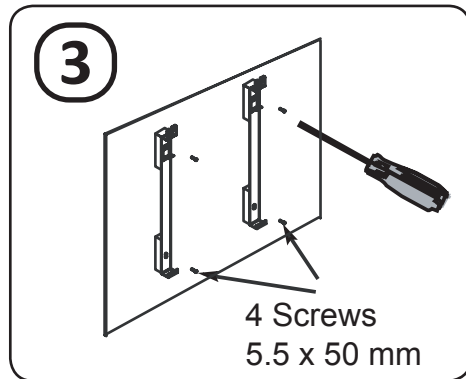
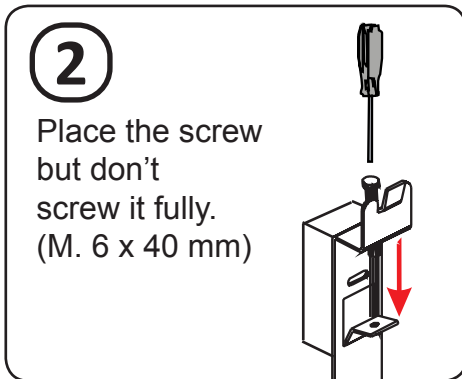
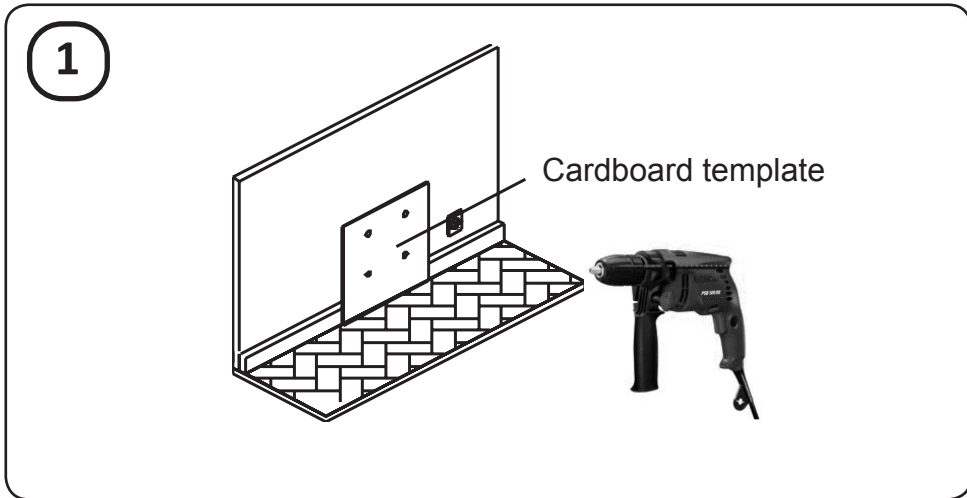

EN

RCBL ▶ 27





EN

2. INSTRUCTIONS FOR INSTALLATION

6



IMPORTANT:
Screw down
FULLY to lock
the radiator

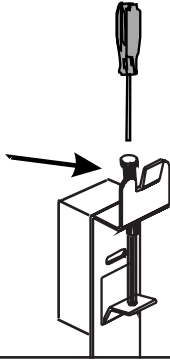

7

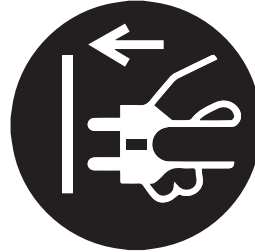

8

Press ON /
OFF switch
located at the
right rear part
of the unit.

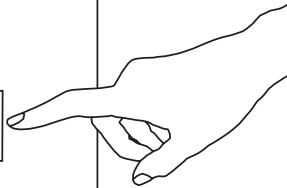

INFORMATION

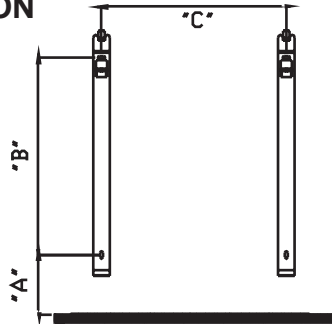

(W)	"A" (mm)	"B" (mm)	"C" (mm)
1000	320	132	560
1250	320	132	560
1500	320	132	885





3. OPERATION

EN

3.1 CONTROL PANEL

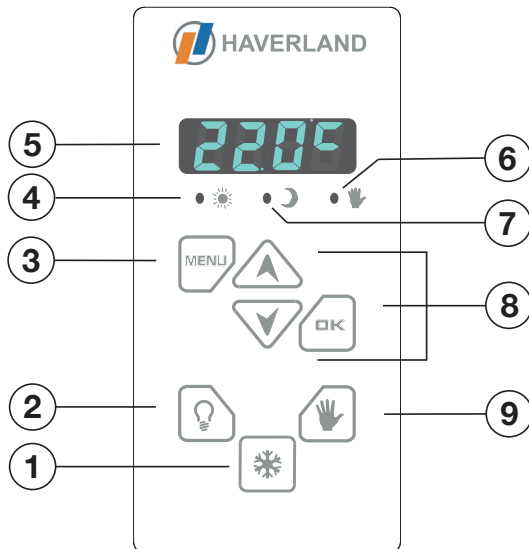

1. Anti-freeze mode button
2. On/off screen light Manual mode button
3. Programming menu button
4. Comfort LED
5. Screen
6. Manual mode LED
7. Economy LED
8. Selection of temperatures and other parameters
9. Manual mode button

3.2 START - FIRST CONNECTION

When the radiator is connected to the mains, press the switch on the position ON:

1. If this is the first time the radiator is connected, "Pr:Hd" will appear flashing on the screen.
2. Press OK button . The room temperature will then be displayed.

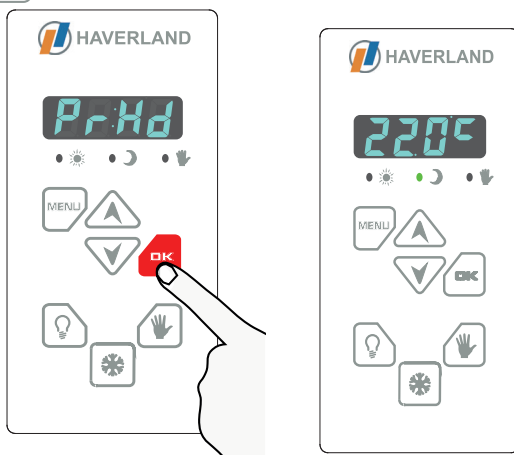

EN





EN

3. OPERATION

3.3 ANTI-FREEZE MODE

By pressing the  button, the radiator changes from “anti-freeze mode” to “heating mode” and vice versa.

The room temperature will be displayed.



The economy LED (moon) will flash approximately every 5 seconds to indicate “anti-freeze mode”.

Anti-Freeze Mode

Flashes every 5 seconds

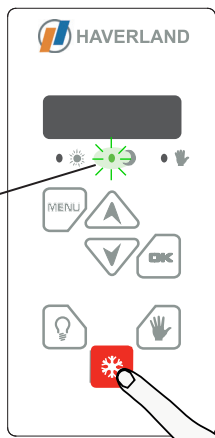

Heating Mode



Remember that you can switch to “anti-freeze mode” by pressing the button .



Thanks to this “**anti-freeze mode**”, extreme temperatures will be avoided in your home, keeping the room temperature at 7°C.

3.4 HEATING MODES



In heating mode, the radiator has two modes of operation, PROGRAMMING mode or MANUAL mode.

Choose the mode of operation by pressing HAND  button.

Programming Mode

Hand LED switched off  

Manual Mode

Hand LED switched on  



3. OPERATION

EN

Programming Mode

In programming mode, the radiator can be in a comfort, economy or anti-freeze cycle.

-  Confort Led
-  Economy Led
-  Economy Led flashing: antifreeze

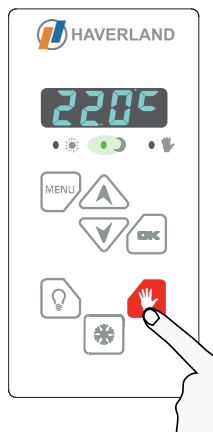

Manual Mode

Hand LED switched on



The comfort (sun) and economy (moon) LEDs will be switched off.



Remember that you can switch to “anti-freeze mode” by pressing the  button.





For an efficient use of your radiator, we recommend using the programming mode. Programme your radiator with the specific times that you require heating in the room.

3.5 MANUAL MODE



In manual mode, the radiator operates as an ambient thermostat.

Once the manual mode has been chosen (hand LED switched on), press the  or  button to configure the desired temperature.

After a few seconds, you will return to the home screen where the room temperature of the room will be displayed.

You can view the chosen temperature at any time by pressing the  or  button.



A bright blue dot will flash on the right side of the screen when the radiator is heating.

EN



EN

3. OPERATION

3.6 SETTING THE THERMOSTAT

To access the set-up menu, **press the  button for 2 seconds.** This will open up the options menu.

With the  button, you can access the sub-menus you want to adjust. The options of the set-up menu are shown in the following diagram:

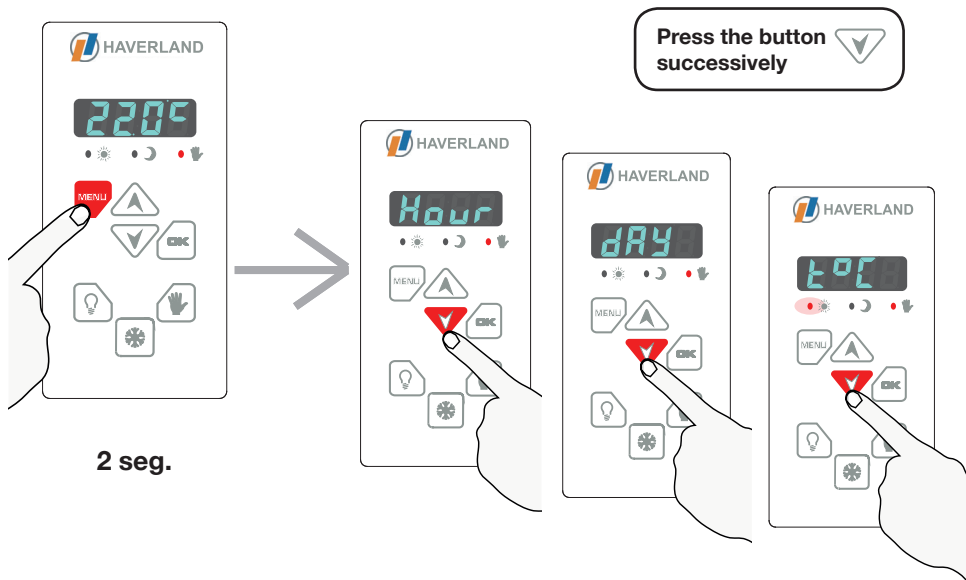



3. OPERATION

EN



To exit the set-up menu, press the  button.

EN





EN

3. OPERATION

3.7 SETTING THE CLOCK

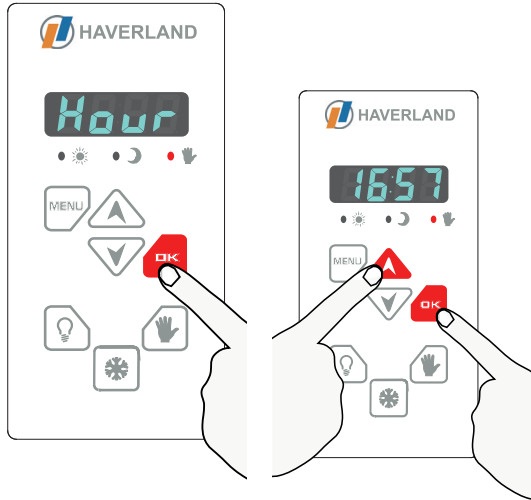

In the “Hour” sub-menu, you can set the current hour and minutes.

Press . The first two digits will flash. Set the current hour by pressing the and buttons.

Press . The minutes will flash. Follow the same procedure by using the arrows to adjust them.

Finish by pressing the button. It will take you to the next set-up sub-menu.

To exit from the set-up menu, press .

3.8 SETTING THE DAY OF THE WEEK

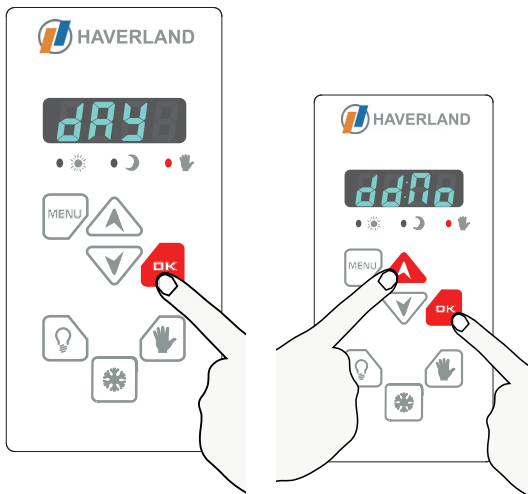

Press . The day of the week will flash.

With the and buttons, set the current day of the week (Mo for Monday, Tu for Tuesday and so on).

Finish by pressing the button. It will take you to the next set-up sub-menu.



3. OPERATION

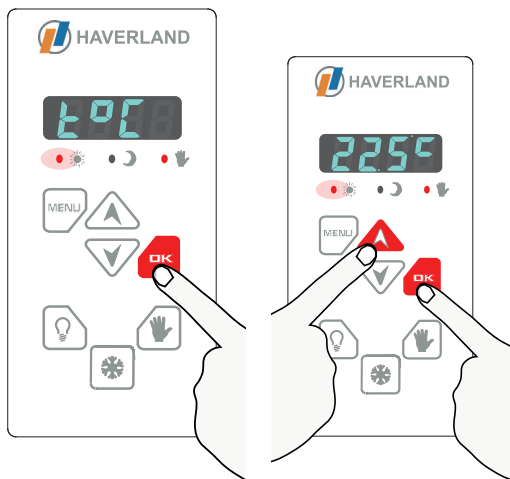

EN

3.9 SETTING THE COMFORT TEMPERATURE



In this sub-menu you can set the desired comfort temperature for the comfort cycles.

The minimum comfort temperature you can set is 5°C and the maximum 32°C. Taking in count that this temperature can not be lower than the economy temperature selected below.

This temperature is adjusted by using the  and  buttons

Finish by pressing the  button. It will take you to the next set-up sub-menu.



The recommended comfort temperature is 21°C.

3.10 SETTING THE ECONOMY TEMPERATURE

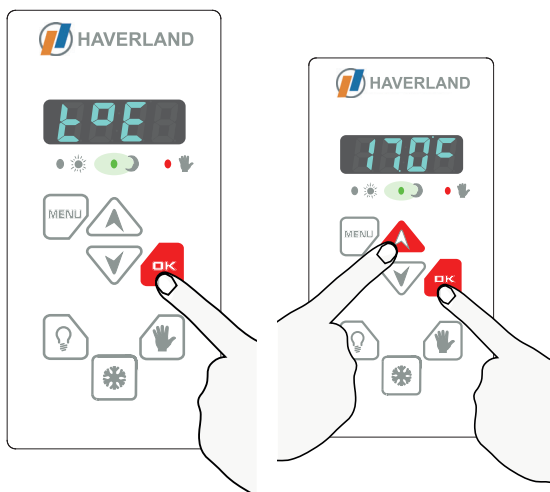

In this sub-menu you can set the desired economy temperature for the economy cycles.

The minimum economy temperature you can set is 5°C and the maximum 32°C. Taking in count that this temperature can not be higher than the comfort temperature .

Finish by pressing the  button. It will take you to the next set-up sub-menu.



The recommended economy temperature is 17°C.

EN



EN

3. OPERATION

3.11 TIME SCHEDULES

The radiator has **4 preset programme schedules**, configured from the factory, and a **bespoke program**, which can be modified by the user.

These four preset programs are suited for the majority of heating situations you may need.

In this sub-menu you can choose one of the 4 time schedules or the bespoke plan

PL01: - Comfort on Monday to Sunday from 10am to 12am. Remaining hours, economy.

PL02: - Comfort on Monday to Friday from 7am to 9am, 12pm to 4pm and 6pm to 12am. Remaining hours, economy.

- Comfort on Saturday and Sunday from 10am to 12am. Remaining hours, economy.

PL03: - Comfort on Monday to Friday from 6am to 9am and 4pm to 12am. Remaining hours, economy.

- Comfort on Saturday and Sunday from 10am to 12am. Remaining hours, economy.

PL04: - Comfort on Monday to Friday from 6am to 9am and 7pm to 12am. Remaining hours, economy.

- Comfort on Saturday and Sunday from 9am to 11am, 2pm to 4pm and 8pm to 12am. Remaining hours, economy.

The **“PLCF” bespoke program can be modified**. By default, it is set with the following schedule:

PLCF: - Comfort on Monday through Friday from 7am to 2pm and 3pm to 7pm. Remaining hours, economy. On Saturday and Sunday, economy.



The comfort and economy cycles will take into account the comfort and economy temperatures predefined in the previous steps (points 3.9 and 3.10).

PL01, PL02, PL03 and PL04 preset programme schedules:

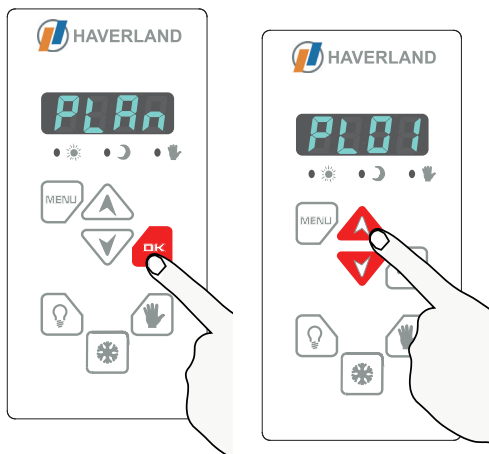

Once the word **“PLAN”** is displayed on the sub-menu, press  to enter the time schedules into the sub-menu.

The **“PL01”** plan will be displayed on screen.

Then, press the  or  buttons to choose the desired programming schedule.

Choose one of the four preset time schedules, for example **“PL02”**.



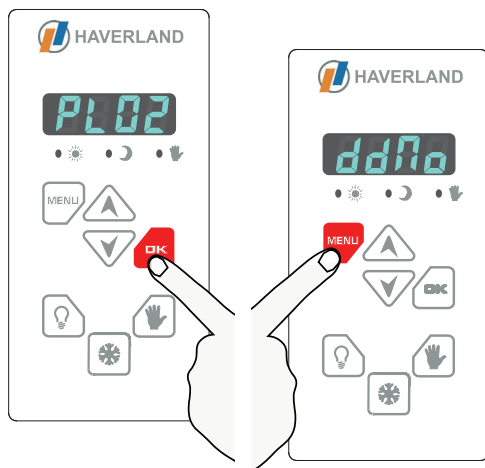

3. OPERATION

EN



Next, press the  button to confirm the chosen time schedule (this will appear on the “ddMo” screen).

 If you wish, you can then check the chosen time schedule by successively pressing the  button.



To validate the chosen plan and complete the setting process, press the  button.

 A bright blue dot will flash on the right side of the screen when the radiator is heating.

 The radiator follows the chosen time schedule in accordance with the comfort and economy temperatures chosen in points 3.9 and 3.10 of this manual.

Configurable PLCF time schedule:

With the bespoke “PLCF” plan you can create a program that suits your needs, day by day and hour by hour.

Choose “PLAN” on the sub-menu, and once you have chosen the configurable “PLCF” plan, press . “ddMo” will be displayed. Then, press  to continue.

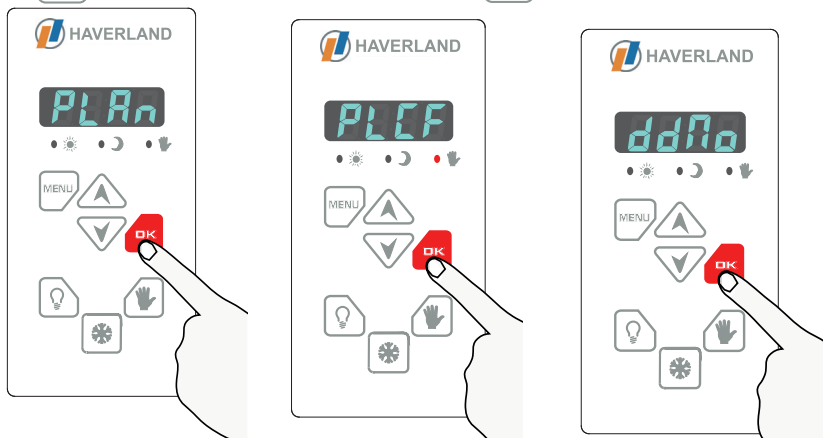

EN

RCBL ▶ 37



EN

3. OPERATION

Then 00:00 will be displayed. With the or buttons, choose the operating cycle: comfort, economy, or anti-freeze, for the first time period (from 12am (00:00) to 1am (01:00)):

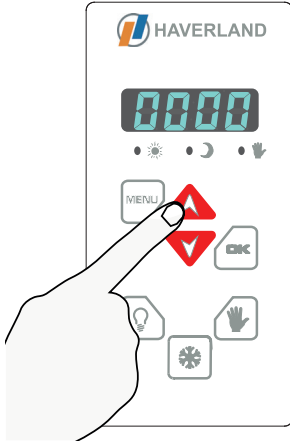

Comfort Cycle = Sun Red LED switched on

Economy Cycle = Moon Green LED switched on

Anti-freeze Cycle = Green LED flashing

The anti-freeze temperature is set at 7°C. This temperature can not be changed.

Press to switch to the next time slot (from 1am to 2am) and repeat the above process to choose the desired operating cycle (comfort, economy or anti-freeze). Repeat the process hour by hour y day by day.



Once you have set the time schedule for the entire week, the radiator will follow this chosen plan. Please make sure that the radiator is on the **PROGRAMMING mode** (hand LED switched off).

A bright blue dot will flash on the right side of the screen when the radiator is heating.

In the "PLCF" plan, the radiator follows the time schedule defined by the user, according to their needs and in accordance with the indicated comfort, economy or anti-freeze cycles.

If you wish to change a specific time slot, please select the day of the week and search for that time slot by pressing the button. Once you have made the changes, in order to exit the menu please press the button repeatedly until you exit of the sub-menu and the room temperature is displayed again.





3. OPERATION

EN

3.12 CONSUMPTION INDICATOR FUNCTION

The radiator incorporates a function that is unique on the market, which enables you to find out its electricity consumption.

Once positioned on the “WAT” sub-menu, press  to access this function.

The energy meter will tell you the sum of the accumulated KWh every 24 hours up to the latest restart.

This meter is restarted every 30 calendar days. It can also be restarted at any time by pressing the  button for 2 seconds.

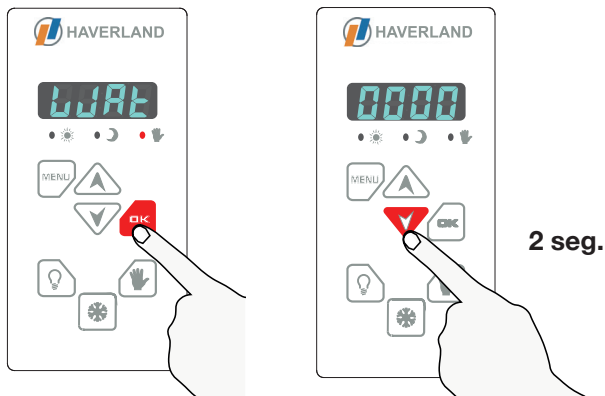

3.13 "OPEN WINDOWS" FUNCTION

This function is activated when there is a sudden drop in temperature in the room.



When this function activates, the green “moon” LED will flash and “Win” will appear flashing on the screen. The radiator will switch to Antifreeze mode, avoiding an unnecessary energy consumption.

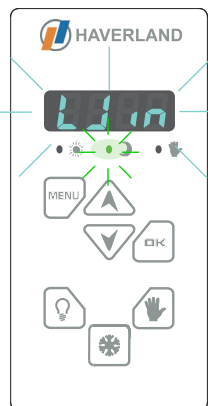

EN

When the window is closed, the radiator will detect a rise in temperature and this function will deactivate. The radiator will switch on again, returning to the state it was in before it was disconnected.



RCBL ► 39









EN

3. OPERATION

 This function can be activated or deactivated by the user. Once positioned in the “Win” sub-menu, press  to access this function.

Next, press the  or  buttons to choose “ON” or “OFF” which activates or deactivates this function.

Then press  to validate. Press  to exit from the menu.

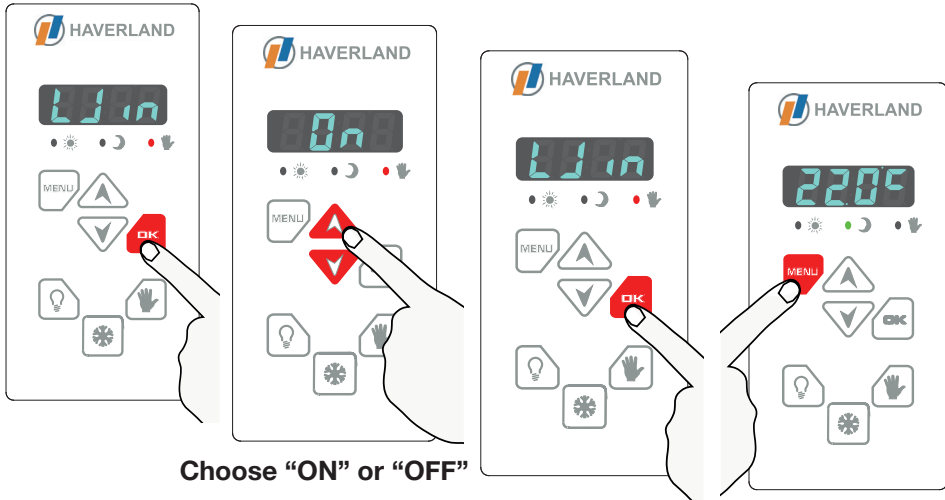





3.14 INTELLIGENT ITCS FUNCTION



The radiator incorporates an innovative intelligent ITCS temperature control system.

This system activates the start-up of the radiator prior to the programmed time (2 hours maximum), to ensure that the desired temperature is achieved at the indicated time and following the established weekly programme.

This intelligent function is factory set. It can be deactivated by the user.

 This function can be activated or deactivated by the user. Once positioned in the “ItcS” sub-menu, press  to access this function.

Next, press the  or  buttons to choose “ON” or “OFF” which activates or deactivates this function.

Then press  to validate. Press  to exit from the menu.





3. OPERATION

EN

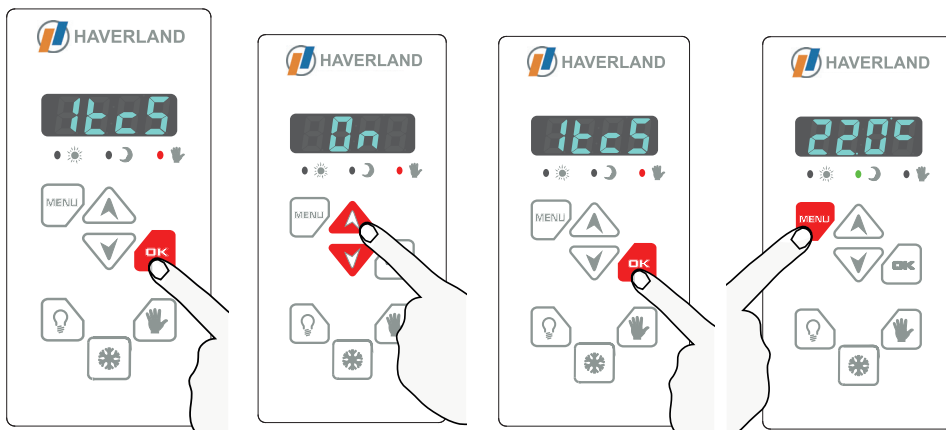

Choose "ON" or "OFF"





The C segments will rotate when this ltc function is activated.

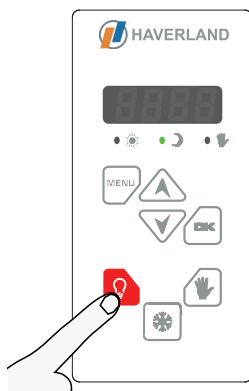

3.15 SWITCH OFF THE DISPLAY



To switch off the screen, press the  button.
Press the  button again to switch the screen back on.



The mode indicator lights will remain turned ON. A bright blue dot will flash on the right side of the screen if the radiator is heating.

EN





EN

3. OPERATION

3.16 KEYBOARD LOCK

Simultaneously press the  and  buttons until “Loc” is displayed.

The same operation must be followed to unlock the keyboard. Then “unlo” will be displayed.

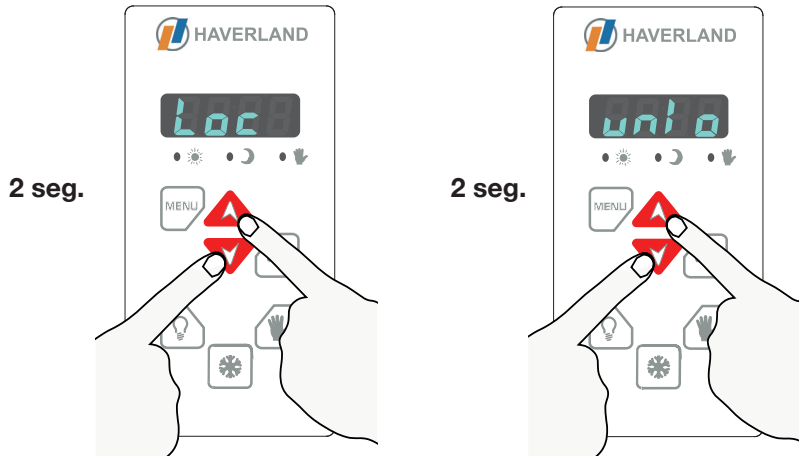

3.17 2 HOUR BOOST FEATURE

The boost feature applies full power to the unit for 2 hours, regardless of the operation mode it's working on. This feature has priority over any other.

To activate it, press the  button for 10 seconds until “booS” is displayed.

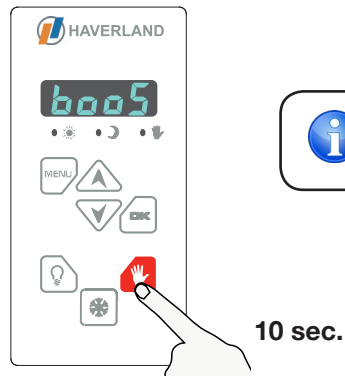

When this feature is activated, “booS” will be displayed.

You can deactivate the Boost feature before the 2 hour period ends by pressing the  or  buttons.

42 ► RCBL



3. OPERATION

EN

3.18 CHANGING THE LANGUAGE

The menu of the radiator can be set into various languages (Spanish, English or French).

Access the set-up menu by pressing the  button for 2 seconds.

Press the  button to change from one language to another.

When you have chosen the desired language, press the  .

Press the  button to exit from the set-up menu.

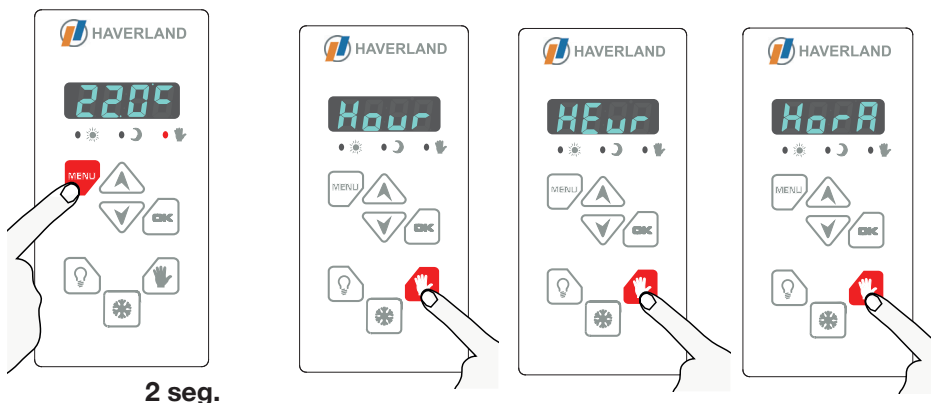

3.19 DISCONNECTION FROM THE MAINS/POWER CUT

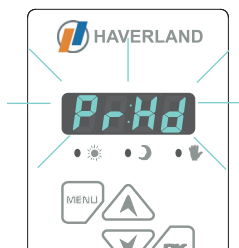

If there is a disconnection from the mains or a power cut that lasts more than 24 hours, you must re-set the day and time.

See point 3.2 regarding "START-UP - FIRST CONNECTION" manual. Set the day and time again by following points 3.7 and 3.8 on this manual.

If the electricity disconnection or power cut supply lasts less than 24 hours, all parameters will be maintained. It will even remember the last operating modes and chosen comfort and economy temperatures.

4. MAINTENANCE

EN

Your heater does not need any kind of special maintenance.

Just remove any dust with a soft dry cloth.

We recommend to start the winter season, by cleaning off the dust that has built up on the heater surface.



NEVER USE SOLVENTS OR ABRASIVE PRODUCTS.

RCBL ► 43



FR

1. AVERTISSEMENTS GÉNÉRAUX

• **Veillez lire les instructions explicatives.**

• Pour déconnecter le radiateur du réseau électrique, retirez le câble d'alimentation de la prise de courant. **Ne jamais tirer du câble électrique.**

• Ne pas laisser le câble de connexion en contact avec l'appareil pendant qu'il est allumé.

• **La garantie de l'appareil ne tiendra pas en compte des dommages causés par la non lecture de ces instructions.**



DANGER: NE PAS COUVRIR L'APPAREIL. NE PAS L'UTILISER POUR SÉCHER LE LINGE. Le couvrir occasionnerait un danger, car il pourrait se produire une surchauffe.



• **DANGER: Si le câble d'alimentation s'abîme il faudra le faire remplacer par un Service Technique Autorisé afin d'éviter un risque quelconque.**



• **DANGER: Si l'appareil va être installé dans une salle de bain, il doit être placé de telle sorte que l'appareil ne puisse pas être touché par n'importe quelle personne qui se trouve dans la baignoire ou la douche.**



• **L'installation doit être effectuée selon les instructions du fabricant et conformément à la législation électrique en vigueur.**

• L'appareil ne doit pas être placé en dessous ou devant une prise de courant.

• Pendant son fonctionnement, il faudra prendre la précaution de maintenir éloigné l'appareil de matériaux combustibles tels que rideaux, moquettes, meubles, etc.

• L'installation doit être effectuée selon la législation électrique en vigueur.

• Cet appareil doit être connecté à une prise de terre.

• Le radiateur doit être installé de telle manière que le câble électrique d'alimentation soit parfaitement accessible.

• **Cet radiateur est un appareil qui doit être fixé au mur. Ce radiateur ne doit pas être encastré. Respectez toujours les distances de sécurité.**

• **Pour éviter que les enfants ne puissent modifier la programmation de l'émetteur, ce-lui-ci dispose d'un blocage.**

• Cet appareil n'est pas conçu pour être utilisé par des personnes (y compris les enfants) ayant des capacités physiques, sensorielles ou mentales réduites, avec peu d'expérience ou de connaissance, à moins qu'elles ne soient sous la supervision d'une personne responsable de leur sécurité, avec les instructions d'usage de l'appareil. Les enfants doivent être supervisés pour s'assurer qu'ils ne jouent pas avec l'appareil.

• Les enfants âgés de moins de 3 ans doivent se maintenir hors de portée de l'appareil, à moins qu'ils ne soient continuellement supervisés.

• Les enfants de 3 ans à 8 ans peuvent allumer / éteindre l'appareil, seulement





1. AVERTISSEMENTS GÉNÉRAUX

FR

si celui-ci a été placé ou installé dans sa position de fonctionnement normal prévue, et s'ils sont supervisés ou qu'ils ont reçu des instructions relatives à l'usage de l'appareil de façon sûre, et aient les risques que renferme l'appareil.

- Les enfants de 3 ans à 8 ans ne doivent pas brancher ni régler, ni nettoyer l'appareil ni réaliser des opérations de maintenance.

- Cet appareil peut être utilisé par les enfants à partir de 8 ans et les personnes avec capacités physiques, sensorielles ou mentales réduites avec peu d'expérience et de connaissance, si elles ont reçu la supervision ou la formation convenable en ce qui concerne l'utilisation de l'appareil de façon sûre et qu'elles comprennent les dangers qu'il implique. Le nettoyage et la maintenance à réaliser par l'utilisateur ne doivent pas être effectués par des enfants. Les enfants ne doivent pas jouer avec l'appareil.



- **PRÉCAUTION : Certaines parties de ce produit peuvent devenir très chaudes et provoquer des brûlures.**

- Avant chaque saison hivernale, ou si l'appareil a été débranché pendant plusieurs jours, nettoyez l'appareil avant de le connecter (suivez les étapes "section Maintenance"). Avec ledit nettoyage, vous éviterez de faire brûler la poussière accumulée et autres restes.

- Il est normal que, lors du premier démarrage, l'appareil puisse dégager une odeur. Faites fonctionner votre émetteur dans un lieu ventilé pendant 2 ou 3 heures.

- Il faudra y accorder une attention particulière lorsque des enfants et/ou des personnes vulnérables seront présents.

- Évitez de toucher les parties externes de l'émetteur pendant son fonctionnement.

- L'émetteur **NE peut pas fonctionner** avec des centrales externes de programmation ou tout autre dispositif de contrôle extérieur.



- **PRÉCAUTION :** Pour éviter tout danger d'asphyxie, gardez ce sac en plastique hors de portée des bébés et des enfants.

- L'effet de la convection, conjointement avec d'autres facteurs environnementaux, peut provoquer une décoloration dans les surfaces métalliques et plastiques.

- Les contrastes de température peuvent générer "des craquements" ou des bruits dans l'appareil. Ceci n'est pas une défaillance du radiateur.

- Cet radiateur a été rempli avec une quantité déterminée d'un fluide thermique spéciale. Par conséquent, dans le cas où les réparations exigent l'ouverture du dépôt où d'éventuelles fuites, celles-ci seront effectuées uniquement par le fabricant ou par le Service Après-Vente.

- Au moment de jeter les radiateurs, il faudra tenir compte des exigences requises par la législation pour le traitement et recyclage des résidus (fluide thermique).

FR





FR

2. INSTRUCTIONS D'INSTALLATION



IMPORTANT

- Il est indispensable de **FIXER FERMEMENT le radiateur A UN MUR SOLIDE ET NIVELÉ.**
- Vérifier qu'il y a une prise de courant proche de l'endroit où vous souhaitez le situer.
- Prenez de l'intérieur de la boîte d'emballage le patron qui indique la position exacte.
- Pour éviter des problèmes, la distance minimum de 15 cm est nécessaire entre le radiateur et tout autres matériaux.

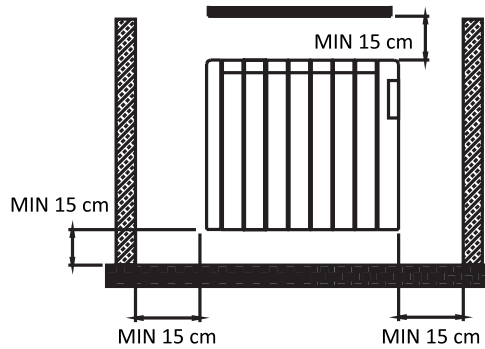



2. INSTRUCTIONS D'INSTALLATION

FR

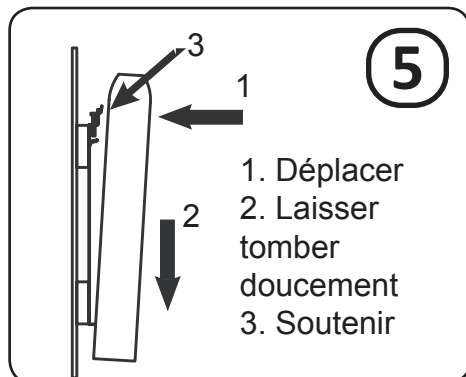
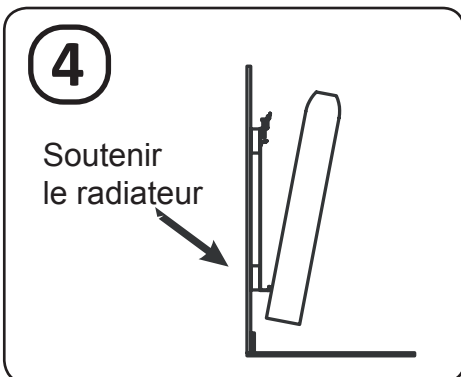
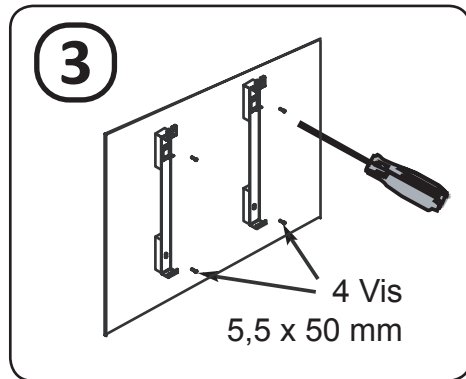
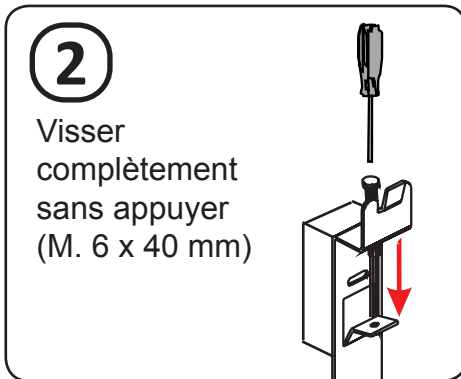
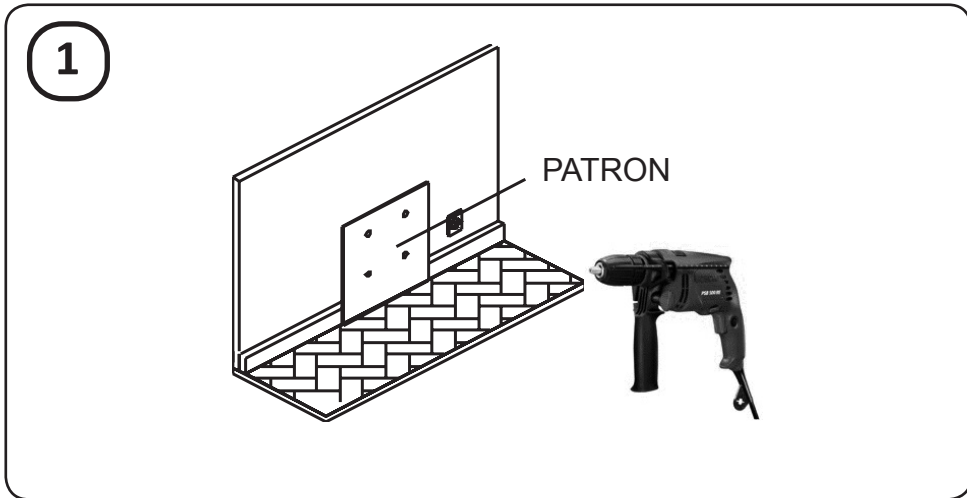

FR

RCBL ►47





FR

2. INSTRUCTIONS D'INSTALLATION

6



IMPORTANT:

Visser complètement pour ajuster le radiateur

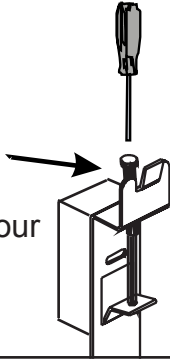

7

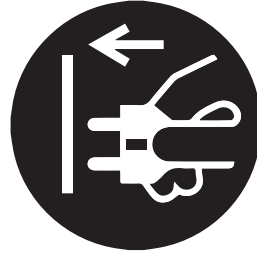

8

L'interrupteur ON / OFF, situé dans la partie postérieure droite de l'appareil.



INFORMATION

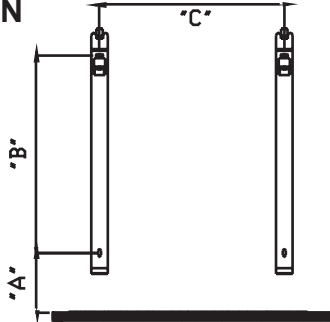

(W)	"A" (mm)	"B" (mm)	"C" (mm)
1000	320	132	560
1250	320	132	560
1500	320	132	885



3. FONCTIONNEMENT

FR

3.1 PANNEAU DE COMMANDE

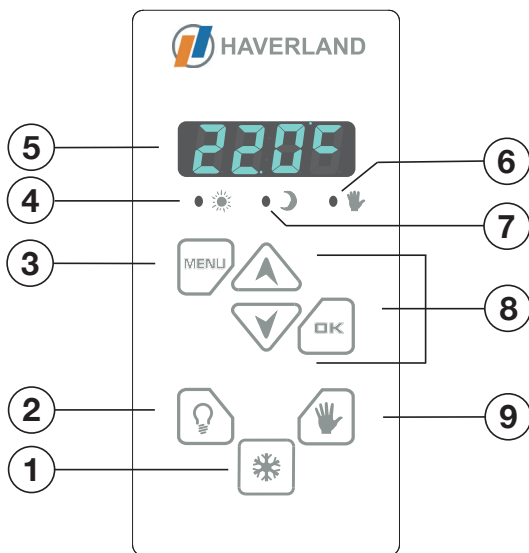

1. Touche mode hors-gel
2. Marche / arrêt éclairage écran
3. Touche menu de programmation
4. LED confort (mode programmé)
5. Écran
6. Led mode manuel
7. LED économie (mode programmé)
8. Sélection de la température et autres paramètres
9. Touche mode manuel

3.2 DÉMARRAGE : PREMIÈRE CONNEXION

Lorsque le radiateur est connecté au réseau électrique, appuyez sur l'interrupteur:

1. Si c'est la première fois, à l'écran clignote "Pr:Hd".
2. Appuyez sur la touche . La température ambiante s'affiche.

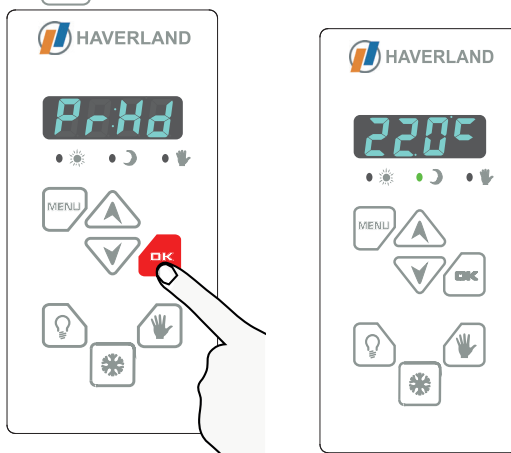

FR

RCBL ► 49

3.3 MODE HORS-GEL

Si vous appuyez sur la touche , le radiateur passe du mode « hors-gel » au mode « chauffage » et vice versa.

L'écran affichera la température ambiante.



Pour indiquer « mode hors-gel » la LED économie (lune) clignotera toutes les 5 secondes environ.

Mode
Hors-gel

Clignotement
toutes les 5
secondes

Mode
Chauffage

Rappelez-vous que vous pouvez passer au mode « hors-gel » en appuyant sur la touche .

Grâce à ce mode « hors-gel », vous éviterez les températures extrêmes dans votre logement, en maintenant la température ambiante à 7°C.

3.4 MODES DE CHAUFFAGE

En mode chauffage, le radiateur dispose de deux modes de fonctionnement, **mode PROGRAMMÉ** ou **MANUEL**.

Choisissez le mode en appuyant sur la touche .

Mode
Programmé

Led Main
éteinte  

Mode
Manuel

Led Main
allumée  

3. FONCTIONNEMENT

FR

Mode Programmé

En mode programmé, le radiateur peut être en cycle de confort, d'économie ou de refroidissement.

-  Led Confort
-  Led Économie
-  Led Économie clignotante: Hors-gel



Mode Manuel

Led main allumée



Les LED confort (soleil) et économie (lune) seront éteintes.



Rappelez-vous que vous pouvez passer au mode « hors-gel » en appuyant 





Pour une utilisation efficace du radiateur, nous vous recommandons d'utiliser le mode programmé. Programmez votre radiateur aux heures spécifiques selon vos besoins de chauffe.



3.5 MODE MANUEL



En mode manuel, le radiateur fonctionne comme un thermostat d'ambiance.

Une fois que vous avez choisi le mode manuel (LED main allumée), appuyez  ou  pour régler la température de consigne souhaitée.

Après quelques secondes, vous revenez à l'écran principal indiquant la température ambiante de la pièce.

À tout moment, vous pouvez afficher la température de consigne choisie en appuyant sur la touche  ou .



Un point lumineux bleu clignotera sur le côté droit de l'écran lorsque le radiateur chauffera.

FR

RCBL ►51



FR

3. FONCTIONNEMENT

3.6 CONFIGURATION DU THERMOSTAT

Pour accéder au menu de configuration, **appuyez sur la touche**  **pendant 2 secondes.** De cette façon, vous entrez dans le menu des options.

Avec le  vous pourrez accéder aux sous-menus que vous souhaitez régler.

Les options du menu de configuration sont présentées dans le schéma suivant:

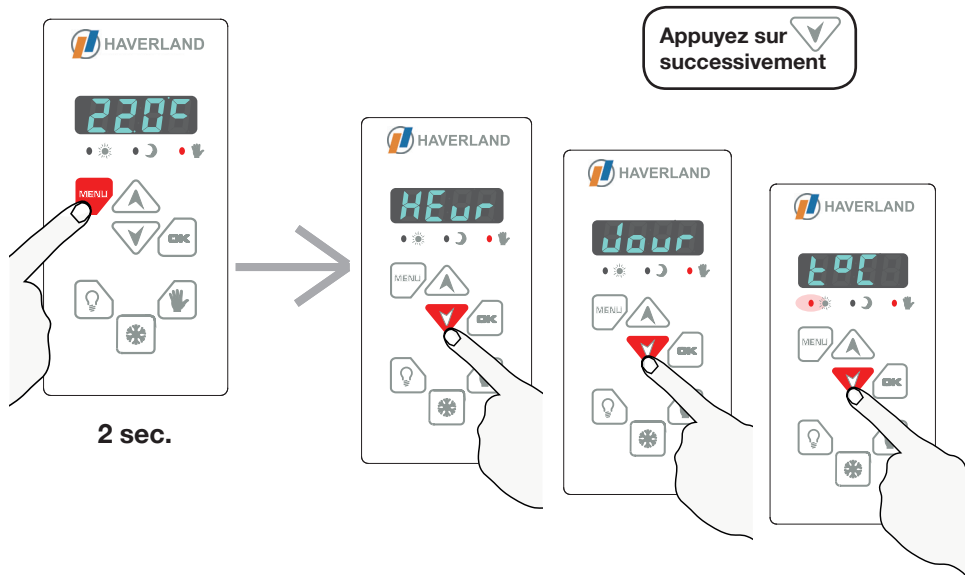



3. FONCTIONNEMENT

FR



Pour quitter le menu de configuration, appuyez sur la touche .

FR

RCBL ► 53



3.7 RÉGLAGE DE L'HEURE

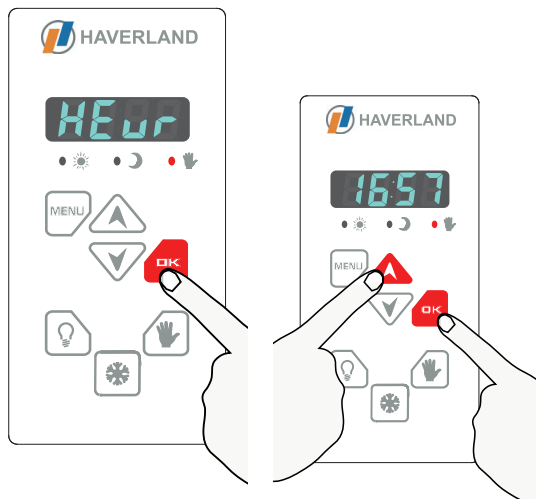

Dans le sous-menu "HorA", vous pouvez régler l'heure et les minutes.

Appuyez sur . Les deux premiers chiffres clignoteront.

Réglez l'heure actuelle à l'aide des touches et .

Appuyez sur .

Les minutes clignoteront.

Suivez la même procédure à l'aide des flèches pour les régler.

Terminez en appuyant sur la touche . Vous passerez au sous-menu de réglage suivant.



Pour quitter le menu de configuration, appuyez sur



3.8 RÉGLAGE DU JOUR DE LA SEMAINE

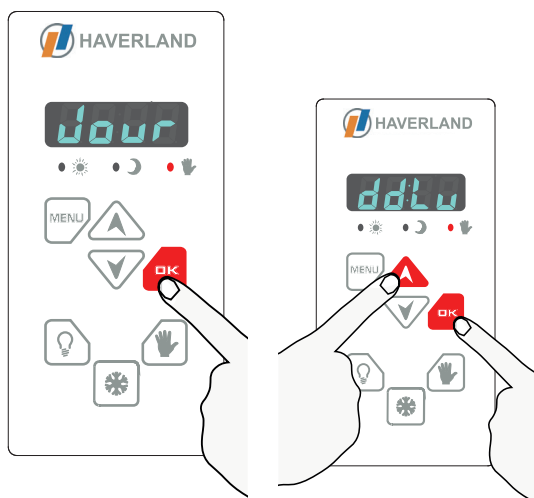

Appuyez sur . Le jour de la semaine clignotera.

Avec les touches et réglez le jour actuel de la semaine.

Terminez en appuyant sur la touche .

Vous passerez au sous-menu de réglage suivant.



3. FONCTIONNEMENT

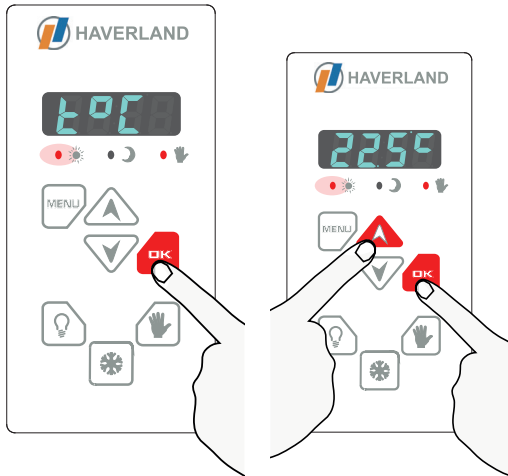

FR

3.9 RÉGLAGE DE LA TEMPÉRATURE CONFORT



Dans ce sous-menu, vous pouvez régler la température de confort souhaitée pour les cycles de confort.

Le réglage peut être effectué entre un minimum de 5° C et un maximum de 32°C par palier de 0,5° C, en tenant compte que cette température ne pourra pas être inférieure à la température d'économie sélectionnée.

Le réglage se fait à l'aide des touches  et .

Terminez en appuyant sur la touche . Vous passerez au sous-menu de réglage suivant.



Température de confort recommandé 21°C.

3.10 RÉGLAGE TEMPÉRATURE D'ÉCONOMIE

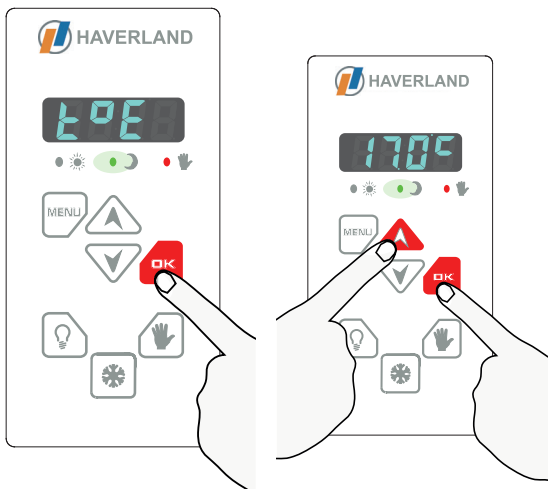

Dans ce sous-menu, vous pouvez régler la température d'économie désirée pour les cycles d'économie.

Le réglage pourra être effectué entre un minimum de 5°C et un maximum de 32°C, en tenant compte que cette température ne pourra pas dépasser la température de confort choisie.”

Terminez en appuyant sur la touche .

Passez au sous-menu de réglage suivant.



Température d'économie recommandée 17°C.

FR





FR

3. FONCTIONNEMENT

3.11 PLANS HORAIRES

Le radiateur thermique dispose de **4 plans horaires programmés en série**, configurés d'usine, et **un plan horaire** configurable, modifiable par l'utilisateur.

Ces 4 plans horaires d'usine **non modifiables** conviennent à la plupart des situations de chauffage dont vous pouvez avoir besoin.

Dans ce sous-menu, vous pouvez choisir un des 4 plans horaires d'usine ou le plan configurable.

PL01: - Confort du lundi au dimanche de 10h à 00h. Le reste des heures, économie.

PL02: - Confort du lundi au vendredi de 7h à 9h, de 12h à 16h et de 18h à 00h. Le reste des heures, économie.

- Confort du samedi au dimanche de 10h à 00h. Le reste des heures, économie.

PL03: - Confort du lundi au vendredi de 6h à 9h et de 16h à 00h. Le reste des heures, économie.

- Confort du samedi au dimanche de 10h à 00h. Le reste des heures, économie.

PL04: - Confort du lundi au vendredi de 9h à 6h et de 19h à 00h. Le reste des heures, économie.

- Confort du samedi au dimanche de 9h à 11h, de 14h à 16h et de 20h à 00h. Le reste des heures, économie.

Le plan configurable "PLCF" est modifiable. Par défaut, il est configuré en usine de la manière suivante :

PLCF: - Confort du lundi au vendredi de 7h à 14h et de 15h à 19h. Le reste des heures, économie. Du samedi au dimanche, économie.



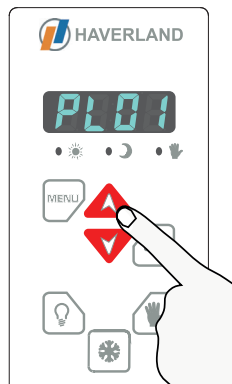
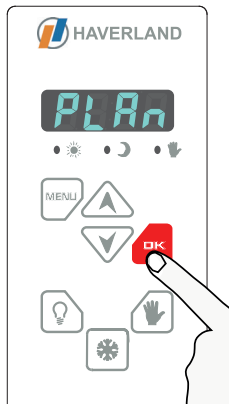

Les cycles de confort et d'économie prendront en compte les températures de confort et d'économie prédéfinies dans les étapes ci-dessus (points 3.9 et 3.10).

Plans horaires prédéfinis de série PL01, PL02, PL03 y PL04:



Une fois que le mot "PLAN" s'affiche, dans le sous-menu, appuyez sur  pour

accéder dans le sous-menu des plans horaires. Le plan "PL01" s'affichera à l'écran. Ensuite, appuyez sur les touches  ou  pour choisir le plan horaire souhaité.

Choisissez un des 4 plans horaires d'usine, par exemple "PL02".



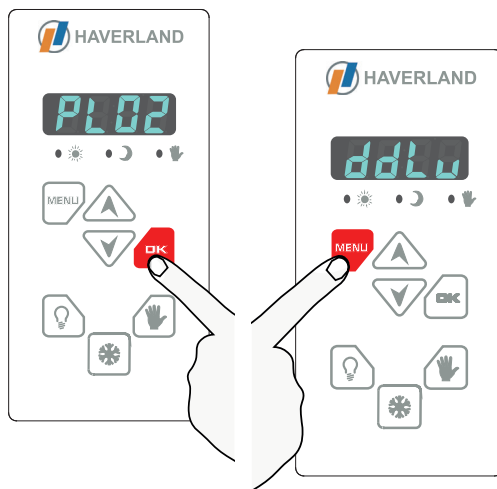

3. FONCTIONNEMENT

FR



Appuyez ensuite sur la touche  pour confirmer le plan horaire choisi ("ddLu" apparaîtra à l'écran).



 Puis, si vous le souhaitez, vous pouvez consulter le plan horaire choisi en appuyant successivement la touche .

Pour valider le plan choisi et finaliser le processus de configuration, appuyez sur la touche .

 Un point lumineux bleu clignotera sur le côté droit de l'écran lorsque le radiateur chauffera.

 Le radiateur suit le plan horaire choisi en fonction des températures de confort et d'économie choisies aux points 3.9 et 3.10 de ce manuel.

Plan horaire configurable PLCF:

Dans le plan modifiable "PLCF" vous pouvez réaliser un programme qui vous convient, jour par jour, heure par heure. Dans le sous-menu "PLAn" et une fois choisi le plan configurable "PLCF" appuyez sur  "ddLu" s'affichera à l'écran. Ensuite, appuyez sur  pour continuer.

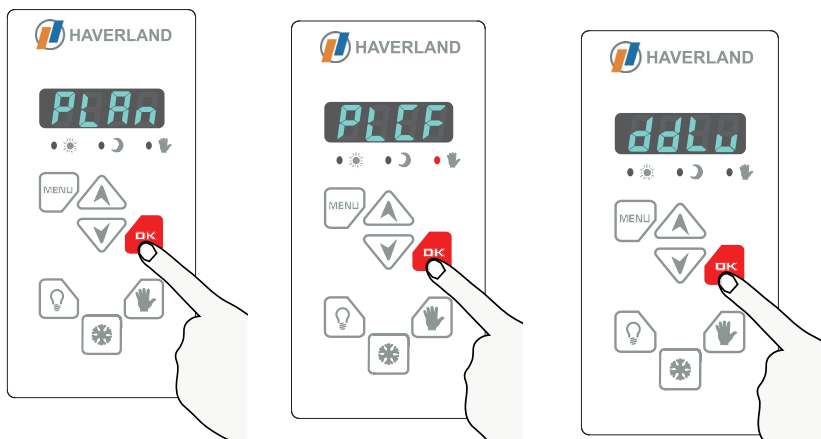



FR

RCBL ► 57





FR

3. FONCTIONNEMENT

L'écran affichera « 00:00 ». À l'aide des touches  ou , sélectionnez le cycle de fonctionnement, confort, économie ou hors-gel, pour la première tranche horaire (de 00h à 1h):



Cycle Confort = LED soleil allumé 

Cycle Économie = LED lune allumée 

Cycle Hors-gel = LED verte clignotante 



La température hors-gel est réglée à 7 °C.

Appuyez sur  pour passer à la créneaux horaire suivante (de 1h à 2h) et renouvelez le processus ci-dessous pour choisir le cycle de fonctionnement souhaité (confort, économie ou hors-gel). Répétez le processus heure par heure, jour par jour.



Après avoir défini le plan horaire de toute la semaine, le radiateur obéira à ce plan à condition que le mode de fonctionnement choisi soit le **mode PROGRAMMÉ** (Vérifier que la LED « main » est éteinte).



Un point lumineux bleu clignotera sur le côté droit de l'écran lorsque le radiateur chauffera.



Dans le plan "**PLCF**" le radiateur suit le plan horaire défini par l'utilisateur en fonction de ses besoins et en fonction des cycles de confort, économie ou hors-gel indiqués.



Pour modifier le cycle de fonctionnement sur un ou plusieurs créneaux horaires, renouvelez les démarches indiquées antérieurement. Une fois votre plan configurable modifié, sortez du menu programmation en appuyant plusieurs fois la touche  jusqu'à l'apparition à nouveau de la température sur l'écran.





3. FONCTIONNEMENT

FR

3.12 FONCTION INDICATEUR DE CONSOMMATION

Le radiateur comprend une fonction unique sur le marché qui vous permet de connaître votre consommation d'électricité.

Une fois dans le sous-menu "WAT" appuyez sur  pour accéder à cette fonction.

Le compteur d'énergie vous indiquera la somme des KWh accumulés toutes les 24 heures depuis le dernier redémarrage.

Ce compteur est remis à zéro tous les 30 jours. Il peut également être réinitialisé à tout moment en appuyant sur la touche  pendant 2 secondes.

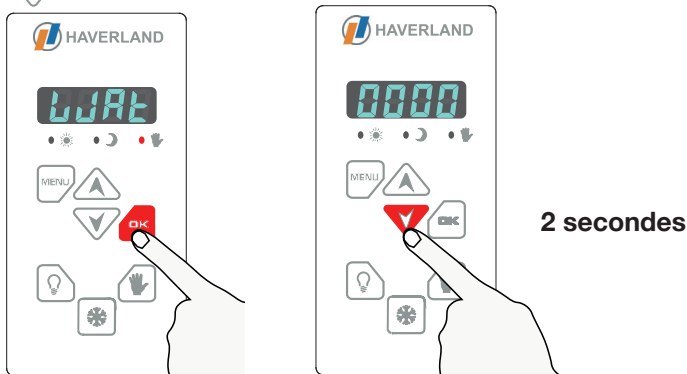

3.13 FONCTION ÉCONOMIE « FENÊTRE OUVERTE »

Cette fonction est activée lorsqu'une baisse soudaine de température se produit dans la pièce.



Lorsque cette fonction est activée, la LED verte « lune » clignote et l'écran clignote "FEn". Le radiateur se déconnectera pour éviter une consommation d'énergie inutile.

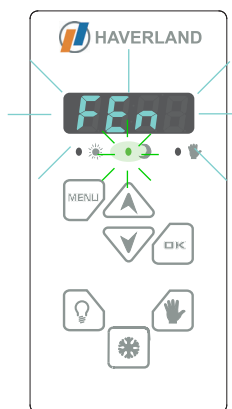

FR

Lors de la fermeture de la fenêtre, le radiateur détectera une augmentation de température et cette fonction sera désactivée. Le radiateur s'allumera à nouveau en revenant la position antérieure de la déconnexion.

RCBL ►59







FR

3. FONCTIONNEMENT



Cette fonction peut être activée ou désactivée par l'utilisateur. Une fois positionné dans le sous-menu "FEn" appuyez sur  pour accéder à cette fonction.

Appuyez ensuite sur les touches  ou  pour choisir « Marche » ou « Arrêt » et activez ou désactivez cette fonction. Ensuite, appuyez sur  pour confirmer.

Appuyez sur  pour quitter le menu.

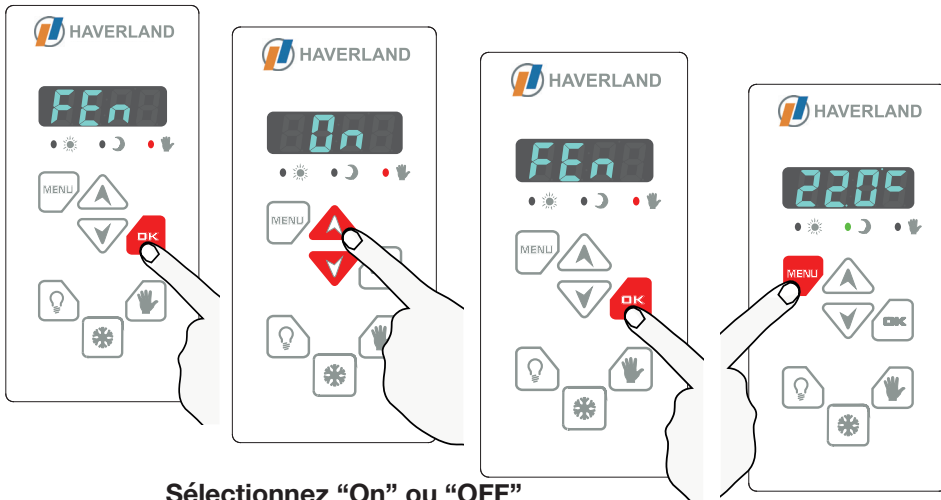

Sélectionnez "On" ou "OFF"

3.14 FONCTION INTELLIGENTE ITCS

Le radiateur comprend un **système de contrôle de température innovant et intelligent**.

Ce système active le lancement de l'émetteur **avant l'heure prévue** (2 heures maximum), afin d'assurer que la température souhaitée soit obtenue à l'heure indiquée et en suivant le programme hebdomadaire établi.

Cette fonction intelligente est activée en série. Elle peut être désactivée par l'utilisateur.



Cette fonction peut être activée ou désactivée par l'utilisateur. Une fois positionné dans le sous-menu "Itcs" appuyez sur  pour accéder à cette fonction.

Appuyez ensuite sur les touches  ou  pour choisir « Marche » ou « Arrêt » et activez ou désactivez cette fonction. Ensuite, appuyez sur  pour confirmer.

Appuyez sur  pour quitter le menu.



3. FONCTIONNEMENT

FR

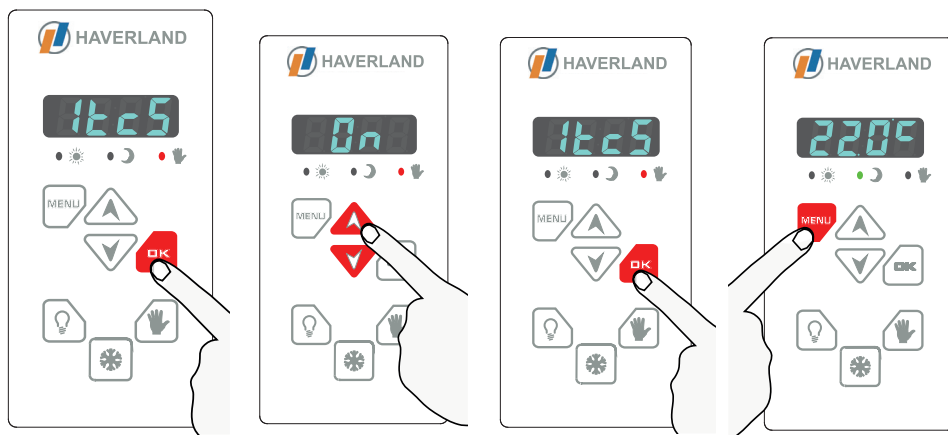

Sélectionnez "On" ou "OFF"





Les segments de la "C" tourneront lorsque cette fonction ItcS sera activée.

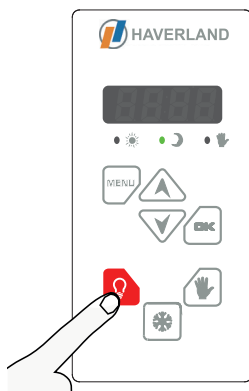

3.15 ÉTEINDRE LE DISPLAY



Pour éteindre l'écran, appuyez sur la touche 
Appuyez à nouveau sur la touche  pour rallumer l'écran.



Un point lumineux bleu clignotera sur le côté droit de l'écran lorsque l'émetteur chauffera.

FR

RCBL ▶ 61



FR

3. FONCTIONNEMENT

3.16 VERROUILLAGE DE CLAVIER

Appuyez simultanément sur les touches  et  jusqu'à affichage du mot **Loc**.

Vous devez effectuer la même opération pour déverrouiller le clavier. Sur l'écran, le mot **unlo** s'affichera.

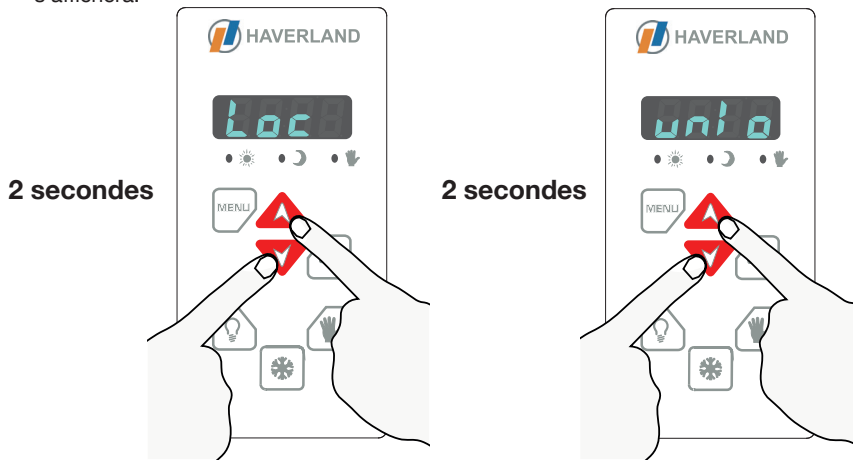

3.17 FONCTION " BOOST " - FONCTION 2 HEURES

Cette fonction met l'appareil en fonctionnement puissance maximale pendant deux heures, quel que soit le mode de fonctionnement sélectionné. Cette fonction est prioritaire sur toute autre.

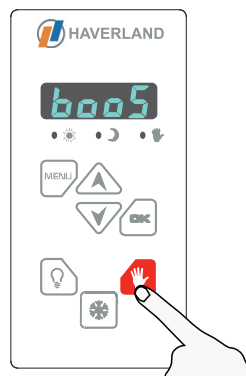

Pour activer cette fonction, appuyez sur la touche  pendant 10 secondes jusqu'à que "**booS**" s'affiche sur l'écran.



10 secondes



Lorsque cette fonction est activée l'écran clignote "**booS**".

Vous pouvez désactiver la fonction " Boost " avant la fin des 2 heures, en appuyant sur la touche  ou la touche .



3. FONCTIONNEMENT

FR

3.18 MODIFICATION DE LA LANGUE

Le menu du radiateur peut être configuré en plusieurs langues (espagnol, anglais ou français).

Entrez dans le menu de configuration en appuyant sur la touche  pendant 2 secondes.

Appuyez sur la touche  pour passer d'une langue à une autre.

Lorsque vous choisissez la langue souhaitée, appuyez sur la touche .

Appuyez sur la touche  pour sortir du menu configuration.

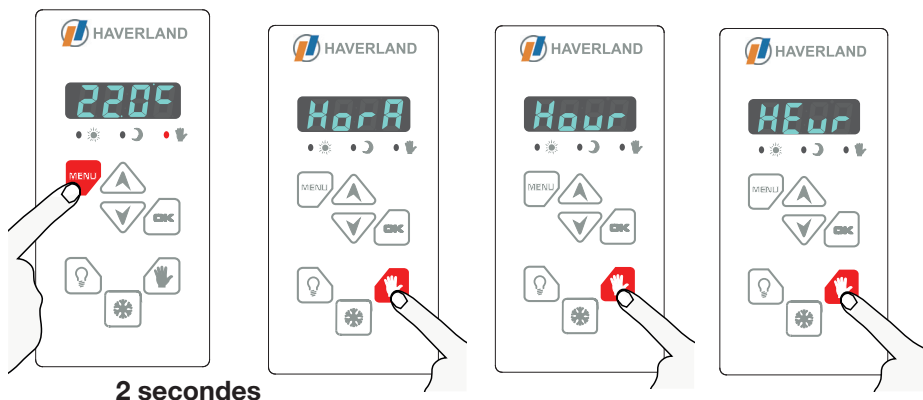

2 secondes

3.19 DÉCONNEXION DU RÉSEAU ÉLECTRIQUE / COUPURE



S'il se produit une **déconnexion** au réseau électrique ou une coupure de courant **supérieure à 24 heures**, vous devez **modifier l'heure et le jour**.

Voir le **point 3.2** du manuel **DÉMARRAGE - PREMIÈRE CONNEXION**.

Reconfigurer le jour et l'heure selon les points **3.7** et **3.8** du manuel.

Si la **déconnexion** ou la coupure de courant **est inférieure à 24 heures**, tous les paramètres sont maintenus, même le dernier mode de fonctionnement et les températures de confort et d'économie sélectionnées.

4. ENTRETIEN

Votre radiateur ne requiert aucun entretien spécial.

Il suffit de retirer la poussière qui peut s'y accumuler avec un chiffon sec et doux.

Au début de la saison de chauffage, il convient d'enlever la poussière accumulée sur l'radiateur.



N'UTILISEZ JAMAIS DES DISSOLVANTS NI DES PRODUITS ABRASIFS.

FR

RCBL ► 63



P

1. ADVERTÊNCIAS GERAIS

• **Leia as instruções de montagem.**

• Para desligar o emissor térmico da rede elétrica, retire a ficha de alimentação da tomada. **Nunca puxe o cabo.**

• Não deixe o cabo de ligação em contacto com o aparelho enquanto este estiver aceso.



• **A garantia do aparelho não cobre o não cumprimento das instruções.**

PERIGO: Não tape o aparelho. Não o use para secar roupa. Se o cobrir, corre o risco de um sobreaquecimento.



• **PERIGO:** Se o cabo de alimentação estiver danificado, deve ser substituído pelo fabricante ou pelo serviço pós-venda.



• **PERIGO:** Num quarto de banho, o aparelho deve ser instalado de forma a não poder tocado por qualquer pessoa que se encontre na banheira ou duche.



• **A instalação deve ser realizada levando em consideração estas instruções e de acordo com a legislação elétrica vigente.**

• Durante o funcionamento deve ter-se em atenção manter o aparelho afastado das matérias inflamáveis, tais como, cortinas, tapetes, móveis, etc.

• Verifique se o emissor está desligado antes de realizar qualquer operação no seu interior.

• Este aparelho deve ser ligado á terra.

• **O emissor deve ser instalado de tal maneira que a ficha de ligação esteja sempre acessível. Este emissor não se deve encastrar. Deve-se respeitar sempre as distâncias de segurança.**

• **O emissor dispõe de um bloqueio para evitar que as crianças alterem a programação.**

• Este aparelho não foi concebido para utilização por pessoas (incluindo crianças) com capacidades físicas, sensoriais ou mentais diminuídas nem com experiência ou conhecimento reduzido, exceto sob supervisão de um responsável pela sua segurança com as instruções de utilização do aparelho. As crianças devem ser vigiadas para garantir que não brincam com o aparelho.

• As crianças com menos de 3 anos devem ser mantidas fora do alcance do aparelho, caso contrario devem estar supervisionadas permanente.

• As crianças com mais de 3 e menos de 8 anos devem só podem ligar/desligar o aparelho (on/off), se este estiver colocado ou instalado na





1. ADVERTENCIAS GERAIS

P

posição de funcionamento definitiva, se estiverem supervisadas ou tenham recebido instruções de como usar o aparelho de forma segura e entenderam os riscos que o aparelho envolve.

- As crianças com mais de 3 anos e menos de 8 anos não devem ligar o aparelho na tomada de rede eléctrica, regular, limpar o aparelho ou realizar operações de manutenção.

- Este aparelho pode ser utilizado por crianças maiores de 8 anos e por pessoas com capacidades físicas, sensoriais ou mentais reduzidas, com pouca experiência ou conhecimento, desde que tenham sido devidamente treinados e são supervisionados por um adulto que conheça os riscos envolvidos.

- A limpeza e a manutenção deve efectuada por pessoas adultas não por crianças. As crianças não devem brincar com o aparelho.

- Deve ter-se um especial cuidado quando estão presentes crianças e pessoas com algum tipo de vulnerabilidade ou deficiência.



- **PERIGO: Algumas peças deste produto podem ficar muito quentes e causar queimaduras.** Deve prestar especial atenção na presença de crianças e de pessoas vulneráveis.



- **PERIGO:** Mantenha os sacos e os restantes acessórios incluídos fora do alcance das crianças.

- Evite tocar nas partes exteriores do emissor durante o funcionamento.

- É normal que na primeira colocação em funcionamento o aparelho liberte um cheiro “a novo”. Deixe o emissor funcionar num local ventilado durante duas ou três horas.

- O emissor **NÃO pode funcionar** com centrais externas de control.

- Antes de cada inverno ou depois de vários dias de inatividade, limpe o aparelho antes de o ligar (siga os passos da secção - Manutenção). Com esta limpeza evitará queimar o pó acumulado e outros resíduos.

- Durante o funcionamento do emissor a convecção emitida junto com outros fatores ambientais podem descolorar as superfícies metálicas.

- Mudanças bruscas de temperatura ambiente podem provocar “estalidos” e/ou ruidos no emisor. Isto não é indicativo de avaria no emisor.

- Este emissor foi cheio com uma quantidade determinada de fluido térmico especial, pelo que as reparações que requeiram a abertura do depósito do emissor ou a presença de fugas, devem ser efectuadas unicamente pelo fabricante ou pelos serviços de assistência técnica.

- Deve ter em conta os requisitos estabelecidos pela legislação para o tratamento e reciclagem de resíduos (fluido térmico) quando deite o aparelho fora.

P





P

2. INSTRUÇÕES DE INSTALAÇÃO



IMPORTANTE

- É indispensável que o emissor **SEJA FIXADO FIRMEMENTE A UMA PAREDE FIXA E NIVELADA.**
- Verifique se há alguma tomada perto de onde o vai colocar.
- Tire de dentro de caixa o escantilhão onde se indica a posição exacta dos furos.
- Para evitar problemas é necessária uma distância mínima de 15 cm entre o emissor e qualquer.

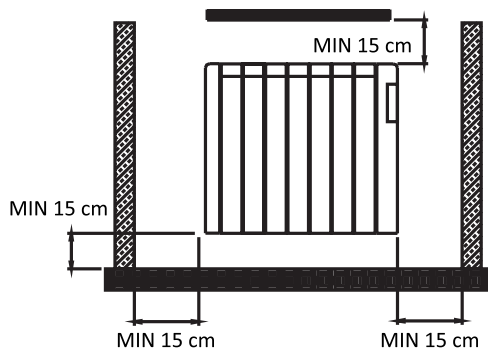



2. INSTRUÇÕES DE INSTALAÇÃO

P

1



2

APONTE O
PARAFUSO ATÉ QUE
TOQUE NA PATILHA
INFERIOR
(M. 6 x 40 mm)

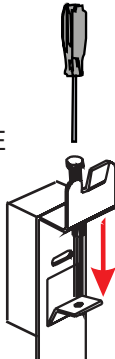

3

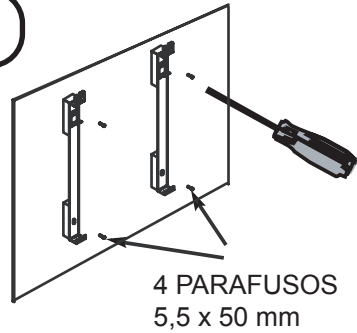

4

APOIE O
EMISSOR

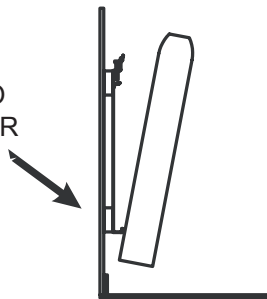

5

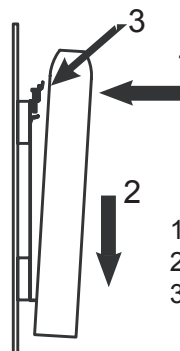

1. DESLOQUE
2. CAIR
3. APOIE

P

RCBL ▶ 67





P

2. INSTRUÇÕES DE INSTALAÇÃO

6



IMPORTANTE:

TERMINE DE APARAFUSAR PARA FIXAR O EMISSOR

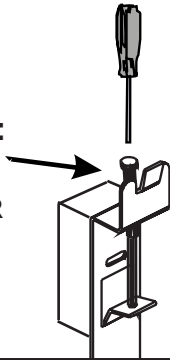

7

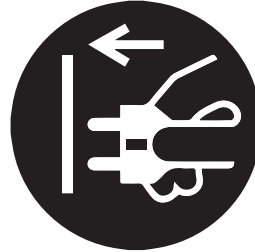

8

Carregue no interruptor ON/OFF, que se encontra na parte posterior direita do aparelho.

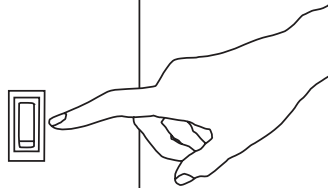

INFORMACIÓN

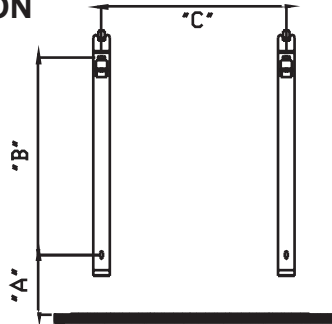

(W)	"A" (mm)	"B" (mm)	"C" (mm)
1000	320	132	560
1250	320	132	560
1500	320	132	885



3. FUNCIONAMENTO

P

3.1 PAINEL DE CONTROLE

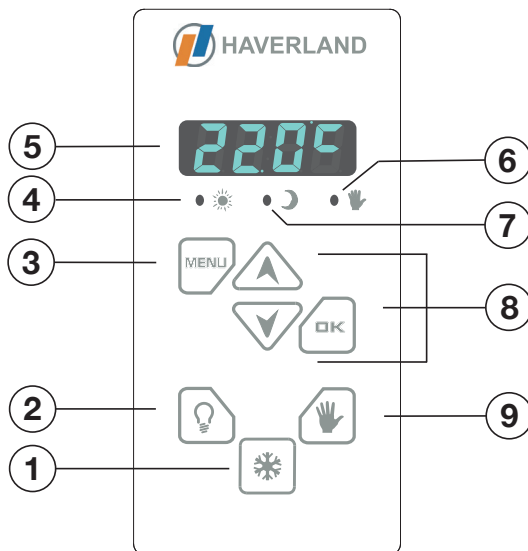

1. Tecla de modo anti-gelo
2. On/off luz do display
3. Tecla menu de programação
4. Led conforto (modo programado)
5. Display
6. LED modo manual
7. Led economia (modo programado)
8. Seleção de temperaturas e outros parâmetros
9. Tecla de modo manual

3.2 INÍCIO - PRIMEIRA LIGAÇÃO

No momento em que o emissor se liga à rede elétrica e se pulsa o interruptor:

1. Se é a primeira vez, aparece a piscar no display: “Pr:Hd”.
2. Pulse a tecla  . A seguir, mostra-se a temperatura ambiente.

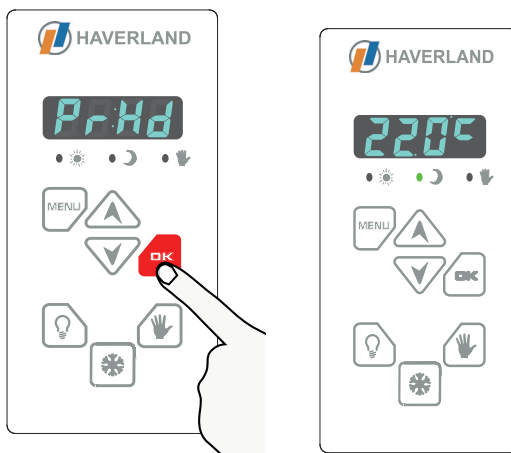

P



P

3. FUNCIONAMENTO

3.3 MODO ANTI-GELO

Pulsando a tecla  o emissor muda do modo “anti-gelo” para o “modo de aquecimento” e viceversa.

No display aparecerá a temperatura ambiente.



Para indicar “modo anti-gelo” o LED Economia (lua) pisca a cada 5 segundos aproximadamente.

Modo Anti-gelo

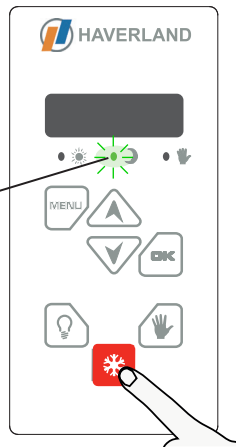

Pisca de 5 em 5 segundos

Modo Aquecimento

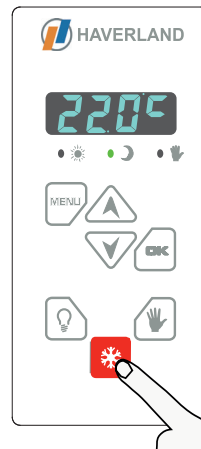

Lembre-se que pode passar para o “modo anti-gelo”, pulsando a tecla . Graças ao **modo anti-gelo** evitará as temperaturas extremas na sua casa, mantendo a temperatura ambiente nos 7°C.

3.4 MODOS DE AQUECIMENTO

No modo aquecimento, o emissor tem dois modos de funcionamento, modo **PROGRAMADO** e modo **MANUAL**.

Escolha o modo de funcionamento pressionando a tecla .

Modo Programado

Led Mão apagado 

Modo Manual

Led Mão aceso 



3. FUNCIONAMENTO

P

Modo Programado

No modo programado o emissor pode estar em ciclo de conforto, de economia ou de anti-gelo.

-  Led Confort
-  Led Economía
-  Led Economía parpadeando: antihielo

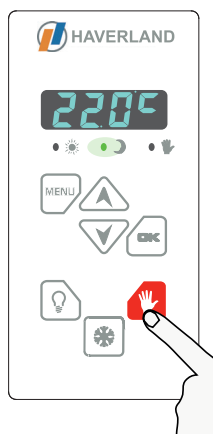

Modo Manual

LED mão acesa



 Os LEDs conforto (sol) e economia (lua) estarão apagados.



Lembre-se que pode passar para o “modo anti-gelo”, pulsando a tecla .





Para o uso eficiente do seu emissor recomendamos o uso do modo programado. Programe o seu emissor com as horas concretas em que necessita aquecimento na estância.



3.5 MODO MANUAL



No modo manual, o emissor funciona como um termostato de ambiente.

Depois de escolher o modo manual (LED mão ligado) pulse a tecla  ou  para definir a temperatura nominal desejada.

Passados uns segundos volta-se ao display principal que indica a temperatura ambiente da quarto.

A qualquer momento pode ver a temperatura nominal escolhida pulsando a tecla  ou .



Um ponto azul piscará no lado direito do display quando o emissor estiver a aquecer.

P

RCBL ► 71



P

3. FUNCIONAMENTO

3.6 CONFIGURAÇÃO DO TERMOSTATO

Para aceder ao menu de configuração, pulse a tecla  durante 2 seg. Desta forma entra no menu de opções.

Com a tecla  pode aceder aos submenus que deseja ajustar.

As opções do menu de configuração aparecem no seguinte esquema:

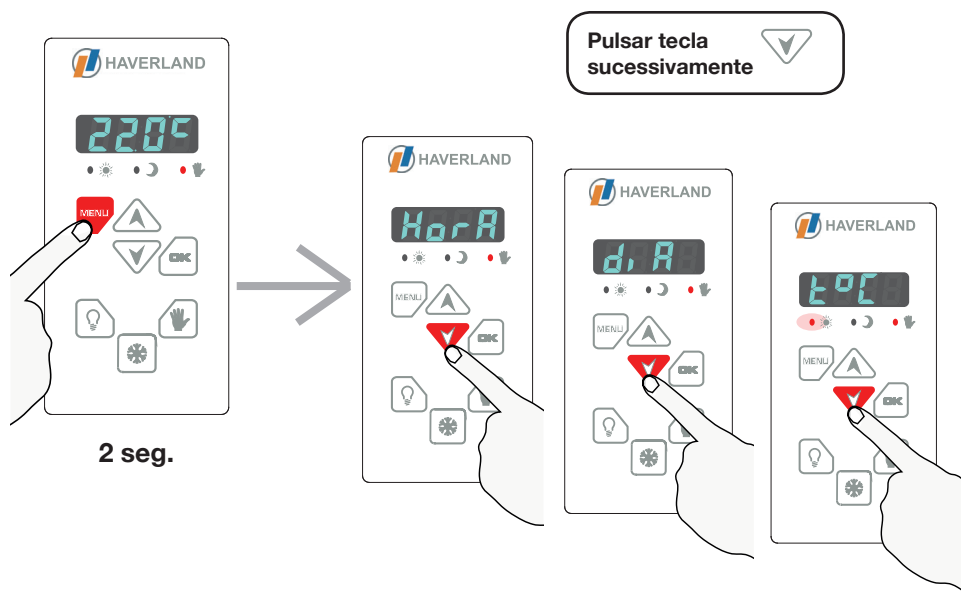



3. FUNCIONAMENTO

P

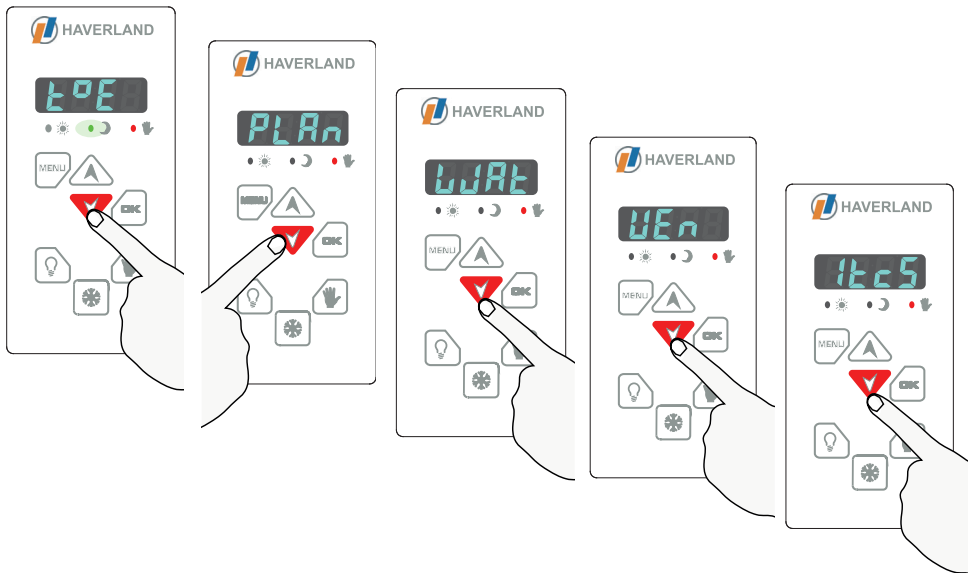

Para sair do menu de configuração pressione a tecla .

P

RCBL ► 73





P

3. FUNCIONAMENTO

3.7 ACERTO DO RELÓGIO

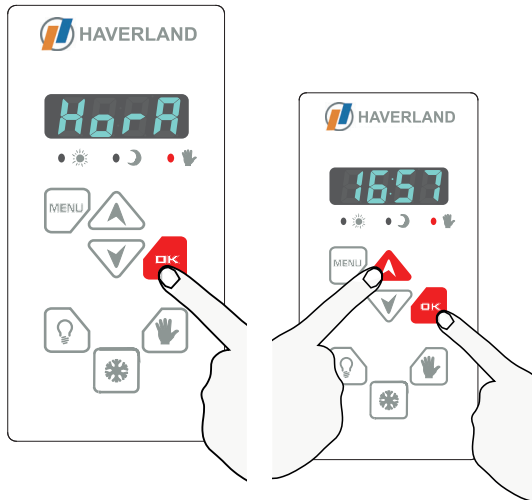

No submenú “HorA”, pode acertar a hora e minutos atuais.

Pulse . Começarão a piscar os dois primeiros dígitos. Acerta a hora mediante as teclas e .

Pulse . Os minutos começarão a piscar.

Siga o mesmo procedimento com as flechas para acertá-los.

Finalize pulsando a tecla .

Passará ao seguinte submenu de ajuste.



Para sair do menu de configuração pulse .

3.8 ACERTO DO DIA DA SEMANA

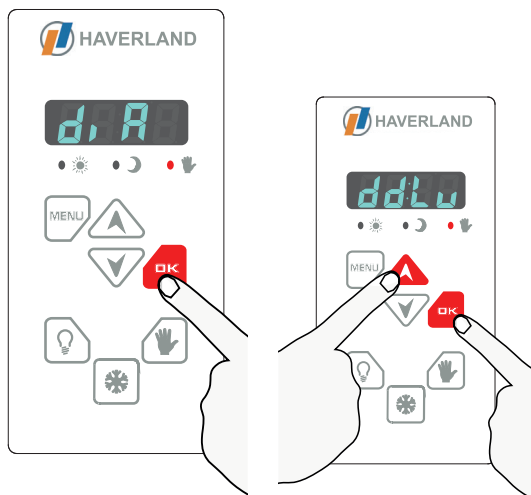

Pulse . O dia da semana começará a piscar.

Com as teclas e acerte o dia da semana.

Finalize pulsando a tecla .

Passará ao seguinte submenu de ajuste.





3. FUNCIONAMENTO

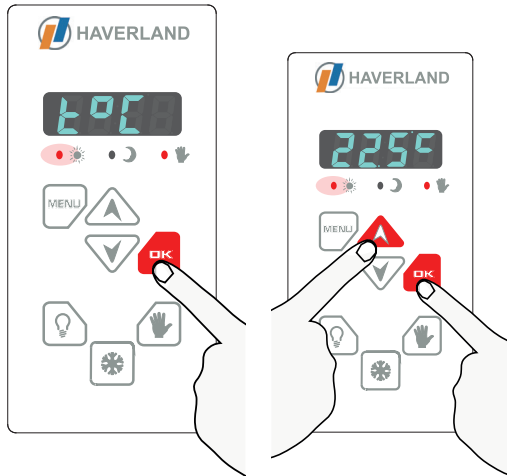

P

3.9 AJUSTE DA TEMPERATURA CONFORTO



Neste submenu pode ajustar a temperatura de conforto desejada para os ciclos de conforto.

O ajuste pode ser efetuado entre um mínimo de 5 ° C e um máximo de 32°C, em intervalos de 0,5 ° C, tendo em conta que esta temperatura não poderá ser inferior à temperatura de economia selecionada.

O ajuste é feito através das teclas  e .

Finalize pulsando a tecla .

Passará ao seguinte submenu de ajuste.



Temperatura de conforto recomendada
21 °C.

3.10 AJUSTE DE TEMPERATURA DE ECONOMIA

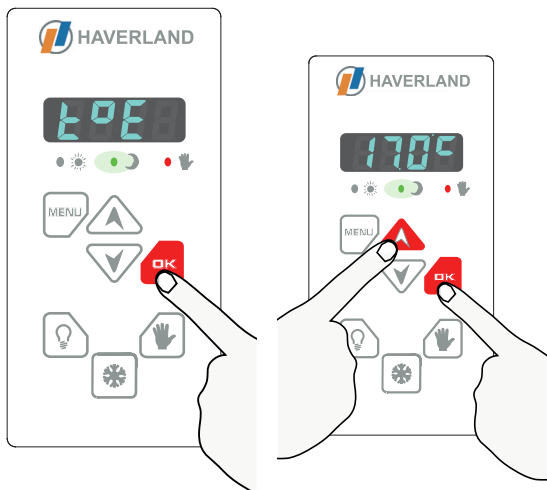

Neste submenu pode ajustar a temperatura de economia desejada para ciclos de economia.

O ajuste pode ser efetuado entre um mínimo de 5 ° C e um máximo de 32 ° C, tendo em conta que esta temperatura não poderá exceder a temperatura de conforto escolhida.

Finalize pulsando a tecla .

Passará ao seguinte submenu de ajuste.



Temperatura de economia recomendada
17 °C

P





P

3. FUNCIONAMENTO

3.11 PROGRAMAS HORÁRIOS

O emissor térmico dispõe de **4 programas horários de série**, configurados desde o seu fabrico, e **um programa horário configurável**, modificável pelo usuário.

Estes 4 programas horários de série, não modificáveis são adequados para a maioria de situações de aquecimento que pode necessitar.

Neste submenu pode escolher um dos 4 programas horários de série ou o programa configurável.

PL01: - Conforto de segunda-feira a domingo das 10 às 24 h. Nas restantes horas em economia.

PL02: - Conforto de segunda a sexta das 7 às 9 h, das 12 às 16 h e das 18 às 24 h.

- Conforto de sábado a domingo, das 10 às 24 h.

PL03: - Conforto de segunda a sexta-feira das 6 às 9h e das 16h às 24h.

- Conforto de sábado a domingo, das 10 às 24 h

PL04: - Conforto de segunda a sexta-feira das 6 às 9h e das 19h às 24h.

- Conforto de sábado a domingo, das 9 às 11h, das 14h às 16h e das 20 às 24 h.

O programa configurável “PLCF” é modificável. Vem predefinido de série da seguinte maneira:

PLCF: - Conforto de segunda a sexta das 7 às 14 h e das 15 às 19 h.

- Sábado e domingo em economia.



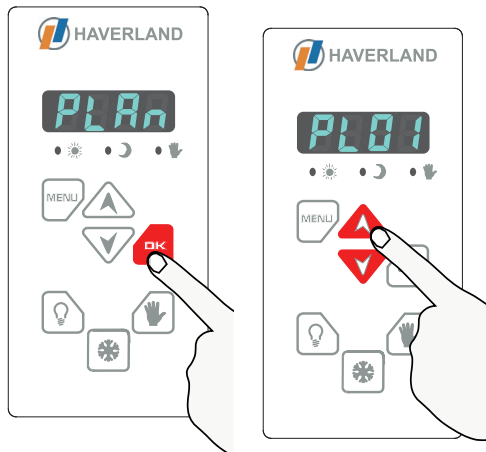

Os ciclos de conforto e de economia, levarão em conta as temperaturas de conforto e de economia predefinidas nos passos anteriores (pontos 3.9 e 3.10).

Programas horários predefinidos de série PL01, PL02, PL03 e PL04:



Quando aparecer a palavra “**PLAn**” no submenu, pulse  para entrar no submenu de programas horários.

Aparecerá o programa “**PL01**” no display.

A seguir pulse as teclas  ou  para escolher o programa horário desejado.

Escolha um dos 4 programas horários de série, por exemplo, “**PL02**”.



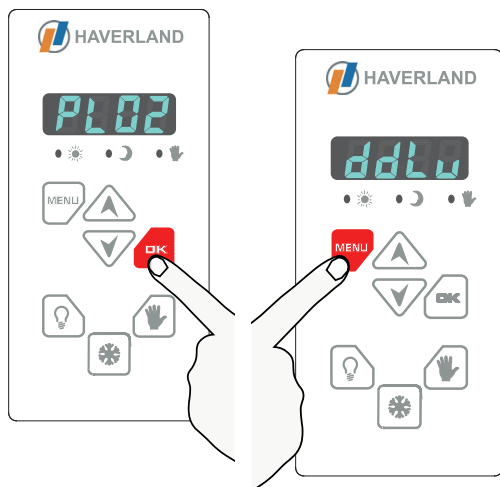

3. FUNCIONAMENTO

P



A seguir, pulse a tecla  para confirmar o programa horário escolhido (aparecerá no display ddLu”).

 Depois, se o desejar, pode comprovar o programa horário escolhido pulsando sucessivamente na tecla .

Para validar o programa escolhido e finalizar o processo de configuração, pulse a tecla .

 Um ponto azul piscará no lado direito do display quando o emissor estiver a aquecer.

 O emissor segue o programa horário escolhido de acordo com as temperaturas de conforto e economia escolhidas nos pontos 3.9 e 3.10 deste manual.

Programa horário configurável PLCF:

O programa modificável “PLCF” pode realizar um programa à sua medida, dia a dia, hora a hora.

No submenu “PLAn” e uma vez escolhido o programa configurável “PLCF” pulse .

Aparecerá “ddLu” no display. A seguir pulse  para continuar.

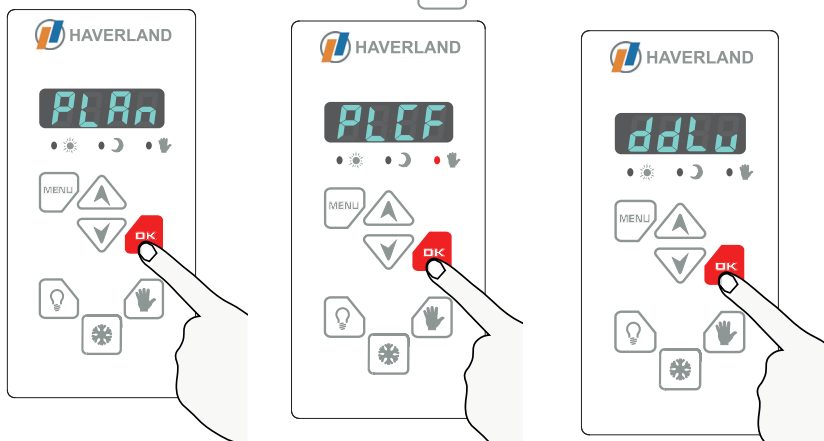

P

RCBL ▶ 77





P

3. FUNCIONAMENTO

O display indicará “00:00”. Com as teclas  ou  escolha o ciclo de funcionamento, conforto, economia ou anti-gelo, para a primeira faixa horária (00: 00h às 01: 00h):



Ciclo Confort = Led sol aceso 

Ciclo Economia = Led luna aceso 

Ciclo anti-gelo = Led verde a piscar 



A temperatura anti-gelo está definida para 7 °C.

Pulse  para passar à faixa horária seguinte (da 01:00 às 02:00 h) e repita o processo anterior para escolher o ciclo de funcionamento desejado (conforto, economia ou anti-gelo). Repita o processo hora por hora, dia por dia.



Uma vez configurado o programa horário para toda a semana, o emissor obedecerá a este programa na condição de que o modo de funcionamento escolhido seja o **modo PROGRAMADO** (comprove que o LED “mão” está desligado).



Um ponto azul brilhante piscará no lado direito do display quando o emissor está a aquecer.



No programa “**PLCF**” o emissor segue o programa definido pelo utilizador segundo as suas necessidades e de acordo com os ciclos de conforto, economia ou anti-gelo indicados.



Para modificar a programação de uma faixa horária repita os passos indicados anteriormente. Depois de modificar seu plano configurável, saia do menu de programação pressionando a tecla várias “” vezes até que a temperatura ambiente seja exibida novamente.



3. FUNCIONAMENTO

P

3.12 FUNÇÃO INDICADOR CONSUMO

O emissor inclui **uma função única no mercado** que lhe permite conhecer o seu consumo elétrico.

Uma vez posicionado no submenu “WAt” pulse  para entrar nesta função.

O contador de energia irá indicar a soma dos KWh acumulados a cada 24 horas desde o último reinício.

Este contador reinicia-se a cada 30 dias. Também pode ser reiniciado a qualquer momento pulsando a tecla  durante 2 segundos.

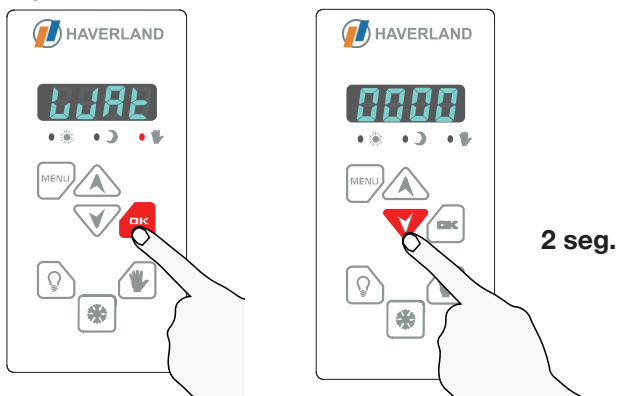

3.13 FUNÇÃO DE POUPANÇA “JANELAS ABERTAS”

Esta função é ativada quando se produz uma queda brusca da temperatura na estância.



Ao ativar-se esta função, o LED verde “lua” começa a piscar e aparece no display piscando “VEn” e o emissor desliga-se, evitando assim o consumo desnecessário de energia.

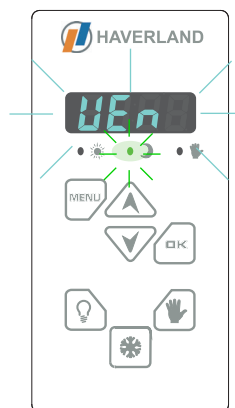

Ao fechar a janela, o emissor deteta um aumento de temperatura e esta função é cancelada. O emissor liga-se novamente, voltando ao estado em que se encontrava antes de ser desligado.

P

RCBL ► 79



P

3. FUNCIONAMENTO



Esta função pode ser ativada ou desativada pelo usuário. Uma vez posicionado no submenu “VEn”, pulse para entrar nesta função.

A seguir, pulse as teclas ou para escolher “On” ou “OFF” para ativar ou desativar esta função.

A seguir, pulse para validar . Pulse para sair do menu.

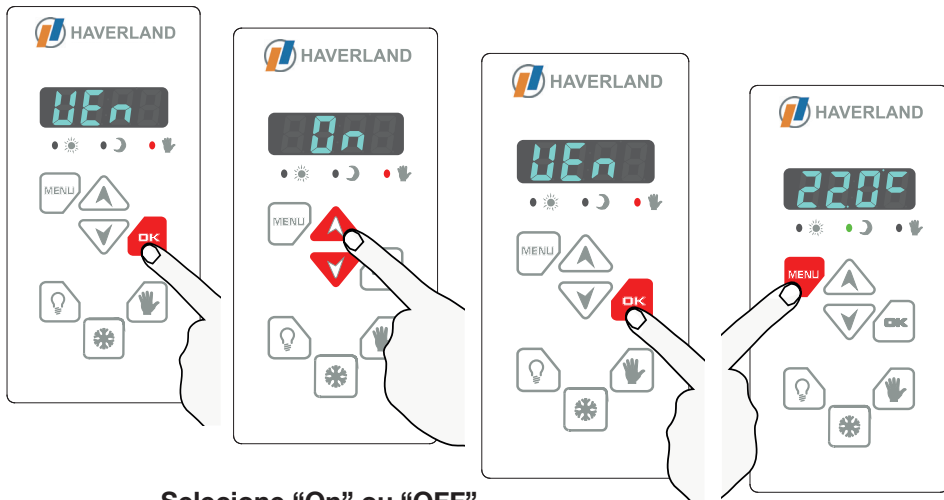

Selecione “On” ou “OFF”

3.14 FUNÇÃO INTELIGENTE ITCS

O emissor inclui um **inovador sistema de controle inteligente de temperatura ITCS**.

Este sistema ativa o arranque do emissor **com base na cedência em relação à hora programada** (2 horas no máximo), para assegurar que se alcançará a temperatura desejada à hora indicada e seguindo o programa semanal estabelecido.

Esta função inteligente vem ativada de série. Pode ser desativada pelo usuário.



Esta função vem activada de série e pode ser desactivada pelo usuário.

Uma vez posicionado no submenu “Itcs” pulse para entrar na função. A seguir pulse as teclas ou para activar ou desactivar a função.

Pulse para validar e sair do menú.



3. FUNCIONAMENTO

P

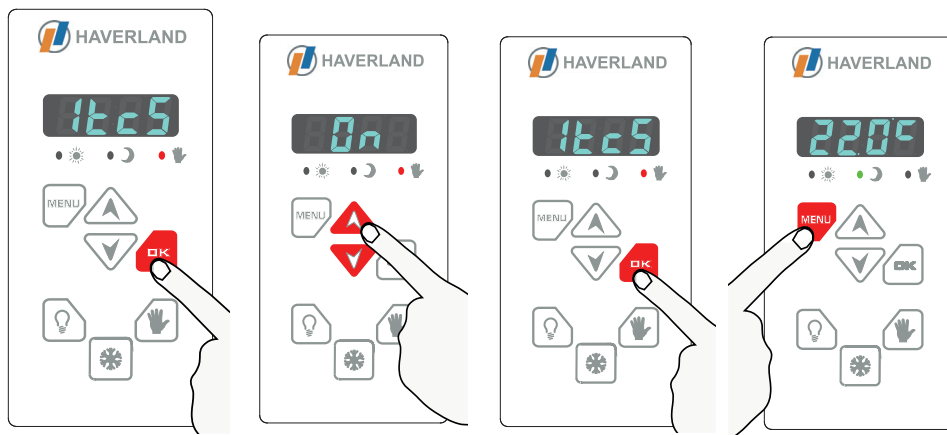

Selecione "On" ou "OFF"



No display os segmentos de la "c" rodam quando a função está a ser executada.

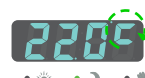

3.15 DESLIGAR O DISPLAY

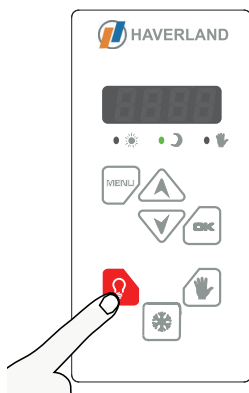

Para desligar o display pulse a tecla .

Pulse a tecla  para voltar a mostrar o display.



Um ponto azul piscará no lado direito do display se o emissor estiver a aquecer.

P



P

3. FUNCIONAMENTO

3.16 BLOQUEIO DO TECLADO

Pulse simultaneamente as teclas  e  até que apareça no display **Loc**.

Deve realizar a mesma operação para desbloquear o teclado. No display aparecerá **unlo**.

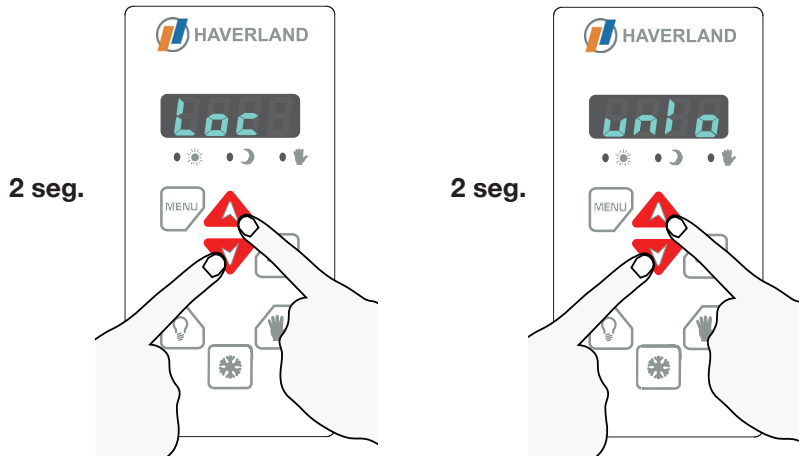



3.17 FUNÇÃO “BOOST” - FUNÇÃO 2 HORAS

Esta função coloca o equipamento em funcionamento na potência máxima durante duas horas, independentemente do modo de funcionamento em que se encontre. Esta função tem prioridade sobre qualquer outra.

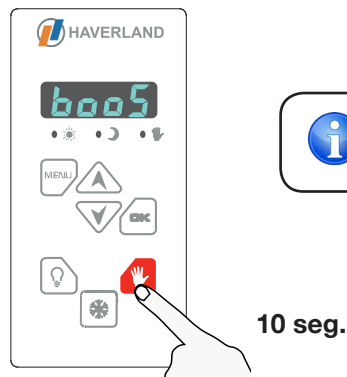
Para ativar esta função pressione a tecla  durante 10 segundos até que apareça “**booS**” no visor.



Ao ativar-se esta função aparece no display “**booS**”.

Pode desativar a função “Boost” antes de terminarem as 2 horas, pressionando a tecla  ou a tecla .



4. OTROS

P

3.18 MUDANÇA DE IDIOMA

O menu do emissor pode ser configurado em vários idiomas (espanhol, inglês ou francês).

Entre no menu de configuração, pulsando a tecla  durante 2 segundos.

Pulse a tecla  para passar de um idioma para outro.

Quando escolher o idioma desejado, pulse a tecla .

Pulse a tecla  para sair do menu de configuração.

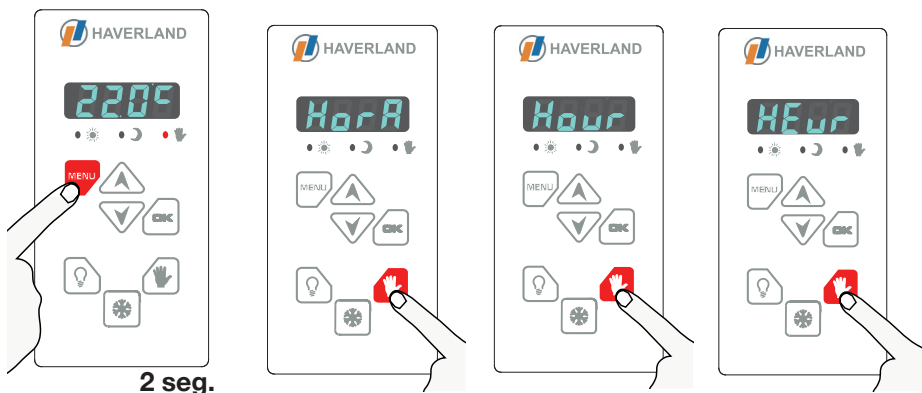

3.19 DESCONEXÃO DA REDE ELÉTRICA / CORTE DO ABASTECIMENTO



Se o emissor se mantiver desligado da rede eléctrica (exemplo: interruptor do emissor desligado) ou há um corte de energia eléctrica superior a 24 horas, aparecerá a piscar o display "Pr:Hd".

Esta informação indica que deve acertar a hora e o dia do seu emissor, siga os passos do manual "INICIO-PRIMEIRA LIGAÇÃO", os restantes parâmetros que tenham sido programados não sofrem alteração.

4. MANUTENÇÃO

Este emissor térmico não requer qualquer manutenção especial.

Limpe simplesmente o pó acumulado com um pano seco e macio.

É conveniente, quando começa o inverno, limpar o pó acumulado na superfície do emissor.



NUNCA UTILIZE SOLVENTES NEM PRODUTOS ABRASIVOS.

P

RCBL ► 83



GARANTÍA

MARSAN INDUSTRIAL, S.A. garantiza la conformidad de los aparatos con las especificaciones del contrato.

Esta garantía cubre la reparación del aparato y comprenderá los gastos necesarios realizados para subsanar la falta de conformidad de los bienes con el contrato.

Dicha subsanación será garantizada durante un plazo de 24 meses desde la fecha de compra conforme a la factura contra cualquier defecto de fabricación y funcionamiento durante el uso normal y doméstico de este producto.

El coste del material (piezas y recambios) será garantizado durante un plazo de 36 meses y por 10 años la estanqueidad del cuerpo de aluminio desde la fecha de compra conforme a la factura.

Esta garantía ampara únicamente el aparato cuyo modelo esté anotado en la factura de compra.

Esta garantía NO CUBRE la instalación inadecuada, el mantenimiento, limpieza o conservación del aparato, así como tampoco las averías motivadas por fuerza mayor, agentes químicos o fenómenos atmosféricos, por uso indebido del aparato, por una instalación eléctrica del comprador defectuosa, transporte del aparato, ni por la manipulación del aparato por personal no autorizado por MARSAN INDUSTRIAL, S.A.

Esta garantía no debe ser modificada, alterada ni extendida, y el Fabricante NO autoriza a nadie a actuar en su nombre en la modificación, alteración o extensión de ésta.

Esta garantía se aplica al Producto solamente.

Para la reparación del aparato, el consumidor deberá dirigirse al Servicio de Asistencia Técnica al teléfono 91 324 40 60 (Horario: Lunes a Viernes de 9 a 20 h) o enviar un correo electrónico a postventa@haverland.com solicitando la información necesaria sobre el procedimiento a seguir.

Para la sustitución, cancelación o rebaja del precio, en su caso, el consumidor deberá dirigirse al establecimiento vendedor. Esta garantía no afecta a los derechos de que dispone el consumidor conforme a las previsiones dispuestas en la Ley 23/2003, de Garantía en la Venta de Bienes de Consumo.



Teléfono Atención al Cliente:
91 324 40 60 (L-V: 9 - 20 h)



E-mail: postventa@haverland.com



La presencia de este símbolo sobre alguno de nuestros productos eléctricos o embalajes de presentación, significa que tales productos no deben tratarse como residuos domésticos convencionales en Europa. Para garantizar el tratamiento adecuado de este tipo de residuos, deshágase de los mismos conforme a las leyes pertinentes o según los requisitos de desecho de equipamiento eléctricos. Al tomar esta iniciativa, estará ayudando a preservar el medio ambiente.

Fabricado en España

Marsan Industrial, S.A. se reserva el derecho a realizar modificaciones sin previo aviso

Marsan Industrial, S.A.
Avda. San Martín de Valdeiglesias, Km. 2,2
28925 Alcorcón (Madrid)
España





GUARANTEE

MARSAN INDUSTRIAL, S.A. guarantees that the devices comply with the contracted specifications.

This warranty only covers the model of heater showed on the valid invoice.

Such rectifications will be guaranteed against any manufacturing and operating defect for the normal and domestic use of this product, for a period of 24 months as from the purchase date shown on the invoice.

HAVERLAND guarantees against material, design or manufacturing faults at the moment of its original acquisition for 2 years. The electronic component and paintwork / finish for 3 years and 10 years for the aluminum body (exclude accidental damage, transport, and misuse).

This warranty only covers the device whose model appears on the purchase invoice.

This warranty DOES NOT COVER incorrect installation, maintenance, cleaning or conserving the device, and neither does it cover failures and faults due to force majeure, chemical agents or atmospheric phenomena, incorrect use of the device, the purchaser's faulty electrical installations, transporting the device or problems caused by the device being handled by persons not authorised by MARSAN INDUSTRIAL, S.A.

This warranty must not be modified, altered or extended, and the Manufacturer does not authorise anybody to act on his behalf to modify, alter or extend it.

This warranty applies only to the Product.

To repair the device, the consumer must dial the Technical Assistance Service at 0330 3651940 or send an email to haverland@haverland.co.uk and ask for the information needed about the procedure to follow:

For a replacement, cancellation or price reduction, when in order, the consumer must go the establishment where the device was purchased. This warranty does not affect the consumers' rights as established in the provisions contained In Ley 23/2003, the Consumer Goods Sales Guarantee Act.



Customer Service Telephone:
0330 3651940



E-mail: haverland@haverland.co.uk



Where you see this symbol on any of our electrical products or packaging, it indicates that the relevant electrical product should not be disposed of as general household waste in Europe. To ensure the correct waste treatment of the product, please dispose of it in accordance with any applicable local laws or requirements for disposal of electrical equipment. In so doing, you will help to conserve natural resources and improve standards of environmental protection in treatment and disposal of electrical waste.

Made in Spain

Haverland UK Limited
Challenge House
Sherwood Drive
Bletchley MK3 6DP

Marsan Industrial, S.A. reserves the right to modify without previous warning





GARANTIE

MARSAN INDUSTRIAL, S.A. garantit que les appareils sont conformes aux spécifications du contrat.

Cette garantie couvre la réparation de l'appareil et comprendra les charges nécessaires encourues pour corriger la non-conformité des biens avec le contrat.

Cette correction sera garantie sur une durée de 24 mois après la date d'achat, selon la facture, contre tout défaut de fabrication et de fonctionnement au cours de l'usage normal et domestique de ce produit.

Le coût du matériel (pièces et pièces de rechange) sera garanti pendant une période de 36 mois et l'étanchéité du corps en aluminium, pendant 10 ans après la date d'achat selon la facture.

Cette garantie ne couvre que l'appareil dont le modèle est annoté sur la facture d'achat.

Elle NE COUVRE PAS l'installation incorrecte, l'entretien, le nettoyage ou la conservation de l'appareil, ni les pannes motivées par une cause de force majeure, des agents chimiques ou des phénomènes atmosphériques, par un usage indu de l'appareil, par une installation électrique de l'acheteur défectueuse, par le transport de l'appareil, ni par la manipulation de l'appareil par un personnel non agréé par MARSAN INDUSTRIAL, S.A.

Cette garantie ne doit être ni modifiée ni altérée ni étendue, et le Fabricant n'autorise personne à agir en son nom dans la modification, l'altération ou l'extension de celle-ci.

Cette garantie s'applique uniquement au Produit.

Pour la réparation de l'appareil, le consommateur devra s'adresser au Service d'Assistance Technique en contactant le + 34 91 324 40 60 (Horaire : du lundi au vendredi, de 9 h à 20 h) ou envoyer un email à postventa@haverland.com en sollicitant l'information nécessaire de la démarche à suivre.

Pour demander une substitution, une annulation ou un rabais, le cas échéant, le consommateur devra s'adresser à l'établissement vendeur. Cette garantie n'affecte pas les droits dont dispose le consommateur selon la Loi 23/2003, de Garantie dans la Vente de Biens de Consommation.



Téléphone Service Client:

+ 34 91 324 40 60 (L-V: 9 - 20 h)



E-mail: postventa@haverland.com



Quand vous voyez ce symbole sur l'un de vos produits électriques ou sur l'emballage, ceci veut dire que le produit électrique en question ne doit pas être jeté avec les ordures ménagères ordinaires en Europe. Pour garantir le traitement correct du produit en tant que déchet, veuillez vous en débarrasser conformément à la législation locale applicable ou aux prescriptions relatives à l'élimination des équipements électriques. De cette façon, vous aiderez à préserver de l'environnement.



Fabriqué en Espagne

Marsan Industrial, S.A. se réserve le droit de réaliser des modifications sans avis préalable.

Marsan Industrial, S.A.
Avda. San Martín de Valdeiglesias, Km. 2,2
28925 Alcorcón (Madrid)
Espagne





GARANTIA

A MARSAN INDUSTRIAL, S.A. garante a conformidade dos aparelhos com as especificações do contrato.

Esta garantia cobre a reparação do aparelho e compreende as despesas necessárias e realizadas para resolver a falta de conformidade dos bens com o contrato.

Esta resolução será garantida durante um prazo de 24 meses desde a data de compra segundo a fatura contra qualquer defeito de fabrico e funcionamento durante uma utilização normal e doméstica deste produto.

O custo do material (peças sobresselentes) será garantido durante um prazo de 36 meses e a estanqueidade do corpo de alumínio possui uma garantia de 10 anos a partir da data de compra segundo a fatura.

Esta garantia cobre unicamente o aparelho cujo modelo seja indicado na fatura de compra.

Esta garantia NÃO COBRE uma instalação inadequada, a manutenção, a limpeza ou conservação do aparelho, as avarias causadas por força maior, agentes químicos ou fenómenos atmosféricos, por utilização indevida do aparelho, por instalação eléctrica do comprador defeituosa, por transporte do aparelho nem pela manipulação do aparelho por pessoal não autorizado pela MARSAN INDUSTRIAL, S. A.

Esta garantia não deve ser modificada, alterada nem ampliada e o Fabricante não autoriza ninguém a agir em seu nome para a modificação, alteração ou ampliação da mesma. Esta garantia aplica-se unicamente ao produto.

Para a reparação do aparelho, o consumidor deve contactar o Serviço de Assistência Técnica através do telefone + 34 91 324 40 60 (Horário: segunda a sexta das 09h00 às 20h00) ou enviar um correio eletrónico para postventa@haverland.com, pedindo a informação necessária sobre o procedimento a seguir.

Para a substituição, anulação ou redução do preço, consoante o caso, o consumidor deve contactar o estabelecimento vendedor. Esta garantia não afeta os direitos do consumidor em conformidade com o disposto na Lei 23/2003, sobre a Garantia na Venda de Bens de Consumo.



Apoio ao Cliente:

+ 34 91 324 40 60 (L-V: 9 - 20 h)



E-mail: postventa@haverland.com



Quando encontra este símbolo em qualquer um dos nossos produtos eléctricos ou na respectiva embalagem isso indica que na Europa esse produto eléctrico não deve ser deixado fora juntamente com o lixo doméstico normal. Para assegurar o devido tratamento ecológico deste produto quando o deite fora, é favor acuar em conformidade com as leis ou regulamentos locais aplicáveis para a eliminação de equipamento eléctrico. Se assim o fizer contribui para a protecção ambiental.

Fabricado em Espanha

Marsan Industrial, S.A. reserva-se o direito de realizar modificações sem aviso prévio

Marsan Industrial, S.A.
Avda. San Martín de Valdeiglesias, Km. 2,2
28925 Alcorcón (Madrid)
Espanha





Modelos / Models / Modèles / Modelos	RC9BL	RC11BL	RC13BL		
Potencia calorífica / Heat output / Puissance thermique / Potência calorífica					
Potencia calorífica nominal (kW) Nominal heat output (kW) Puissance thermique nominale (kW) Potência calorífica nominal (kW)	1.0	1.25	1.5		
Potencia calorífica máxima continuada (kW) Maximum continuous heat output (kW) Puissance thermique maximale continue (kW) Potência calorífica máxima contínua (kW)	1.0	1.25	1.5		
Consumo auxiliar de electricidad / Auxiliary electricity consumption / Consommation d'électricité auxiliaire / Consumo de eletricidade auxiliar					
A potencia calorífica nominal (kW) At nominal heat output (kW) À la puissance thermique nominale (kW) À potência calorífica nominal (kW)	1.0	1.25	1.5		
A potencia calorífica mínima (kW) At minimum heat output (kW) À la puissance thermique minimale (kW) À potência calorífica mínima (kW)	1.0	1.25	1.5		
En modo de espera (kW) In standby mode (kW) En mode veille (kW) Em estado de vigília (kW)	N.A.	N.A.	N.A.		
Tipo de control de temperatura interior Type of heat room temperature control Type de contrôle de la température de la pièce Tipo de comando da temperatura interior	Con control electrónico de temperatura interior y temporizador semanal Electronic room temperature control plus week timer Contrôle électronique de la température de la pièce et programmeur hebdomadaire Com comando eletrónico da temperatura interior e temporizador semanal				
Otras opciones de control	- Control de temperatura interior con detección de ventanas abiertas - Con control de puesta en marcha adaptable				
Other control options	- Room temperature control, with open window detection - With adaptive start control				
Autres options de contrôle	- Contrôle de la température de la pièce, avec détecteur de fenêtre ouverte - Contrôle adaptatif de l'activation				
Outras opções de comando	- Comando da temperatura interior, com deteção de janelas abertas - Com comando de arranque adaptativo				
Nombre del fabricante / Name del fabricante / Nom du fabricant / Nome do fabricante	Marsan Industrial, S.A.				
Dirección / Address / Adresse / Endereço	Avda. San Martín de Valdeiglesias, Km 2.2 28925 Alcorcón (Madrid) España / Spain / Espagne / Espanha				

RCBL

	W	Nº 
RC9BL	1000	9
RC11BL	1250	11
RC13BL	1500	13

220 - 240 V 50 Hz

CLASE I / CLASS I / CLASSE I
IP X2

