

harmeni lugo

Digital electric radiator



**INSTRUCTION
& INSTALLATION GUIDE**



Introduction

Harmoni digital radiators are manufactured with high quality components and include an exclusive electronic temperature programmer. Harmoni digital radiators meet all safety and efficiency requirements and are for fixed installations only. Harmoni digital radiators include:

- TFT Screen
- Easy settings and programming
- Precise electronic thermostat

Read the instruction manual carefully to ensure correct operation of the product. It is very important to keep the manual with the product after its installation.

Contents

1. Harmoni Technical Specifications.....	3
2. Installation & Safety precautions.....	4
2.1. Installation precautions.....	4
2.2. Safety precautions.....	4
3. Harmoni system Installation.....	4
3.1. Mounting.....	4
3.2. Fixing the supports.....	5
4. Harmoni system Information & Instructions.....	5
4.1. Touchpad.....	5
4.2. Screen.....	6
4.3. Turn On and Off.....	6
4.4. Submenu configuration.....	7
4.5. Locking touchpad.....	8
4.6. Selecting MANUAL, AUTOMATIC or PILOTE MODE.....	8
4.7. Advance features of the harmoni system.....	11
5. Maintenance & Cleaning.....	11
6. Guarantee.....	12
7. Information requirements for Erp Directive. Commission Regulation (EU) 2015/1188.....	14

1. harmoni Technical Specifications

MODEL	LUGOHS0440T	LUGOHS0660T	LUGOHS0880T	LUGOHS1100T	LUGOHS1320T	LUGOHS1540T
No. Elements	4	6	8	10	12	14
DIMENSIONS						
Width (mm)	425	585	747	907	1,069	1,230
Height (mm)	575	575	575	575	575	575
Depth (mm)	98	98	98	98	98	98
Installed Depth (mm)	120	120	120	120	120	120
MECHANICAL CHARACTERISTICS						
Armoured steel heating element	✓	✓	✓	✓	✓	✓
High purity aluminium	✓	✓	✓	✓	✓	✓
Thermal oil	✓	✓	✓	✓	✓	✓
PC/ABS panel with keypad	✓	✓	✓	✓	✓	✓
Left side cover PC/ABS	✓	✓	✓	✓	✓	✓
Weight (kg)	8	12	16	20	24	28
Finish	White RAL 9010					
ELECTRICAL CHARACTERISTICS						
Nominal Power (W)	440	660	880	1,100	1,320	1,540
Voltage (V)	230 V ~	230 V ~	230 V ~	230 V ~	230 V ~	230 V ~
Current (A)	1.9	2.9	3.8	4.8	5.6	6.7
Power per Element (W/Element)	110	110	110	110	110	110
INSTALLATION & PROTECTION						
Template & Installation Kit	✓	✓	✓	✓	✓	✓
Safety thermostat	✓	✓	✓	✓	✓	✓
Protection Grade	IP 24	IP 24	IP 24	IP 24	IP 24	IP 24

2. Installation & Safety precautions (EN 60335 Standards)

Before switching on the product, please read the "Installation & Safety Precautions" in detail first to ensure the correct operation of the product.

2.1. Installation precautions

The product is designed for household or residential use. You are advised to have the product installed by an authorized professional installer. Make sure the product is properly connected to 230V and is earthed.

2.2. Safety precautions

This appliance can be used by children aged from 8 years and above and persons with reduced physical sensory or mental capabilities or lack of experience and knowledge if they are supervised or have been given instruction concerning use of the appliance in a safe way and understand the hazards involved. Children should not play with the appliance. Cleaning and user maintenance should not be carried out by children without supervision. Children must be supervised at all times to ensure that they do not interfere with the product. This product is filled with a precise amount of special oil that does not need any maintenance. Any repairs requiring the opening of the oil tank must only be done by an official **harmoni** installer or its after-sales service personnel, who should also be notified should an oil leak be noticed. The regulations on discarding oil when the heater is being disposed of must be observed. If the power cable is damaged, it must be replaced by the manufacturer, its after-sales service or authorized personnel in order to avoid any damage.



DO NOT COVER. Do not dry clothes or towels on the heater nor leave fabrics, magazines, spray cans, volatile substances or similar objects within 250mm of the heater.

3. Harmoni system Installation

3.1. Mounting

The product works by means of natural air convection (Figure 1). In order to achieve optimal functioning and an even distribution of heat, the lower part of the product, once mounted on the wall, must be at least 10-12cm from the floor, and 30cm at the most. As for the sides and above, a minimum distance of between 10-12cm must be left from any wall or brickwork in order for it to function correctly (Figure 2).



Figure 1

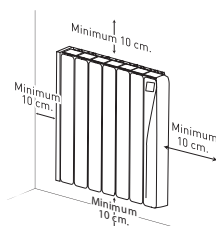
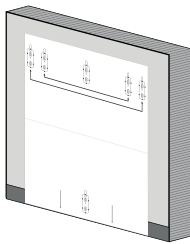
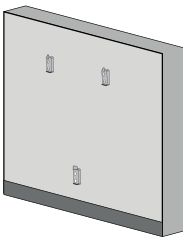
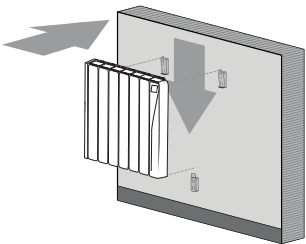

Figure 2

3.2. Fixing the supports

Inside the packaging you will find a fixing kit. Please find the instructions below:

		
<ol style="list-style-type: none"> 1. Choose the right part of the wall. 2. Place the mounting stencil on the wall, marking the places for the holes. 	<ol style="list-style-type: none"> 3. Remove the stencil and make the holes in the wall. 4. Fix the supports using the plugs and screws provided, or others suitable for the wall type. 	<ol style="list-style-type: none"> 5. Check the correct positioning of the lower support. 6. Align the product with the top supports. 7. Place the product in the supports.

4. Harmoni system Information & Instructions

4.1. Touchpad



				
<p>Settings / Back</p>	<p>Decrease Temperature / Move down</p>	<p>ON/OFF / Confirm</p>	<p>Increase Temperature / Move up</p>	<p>Manual mode/ Automatic mode</p>

4.2. Screen

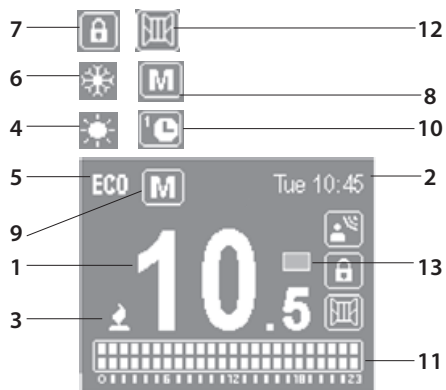

1	Selected temperature	10.5	8	Manual mode	M
2	Current time and day	Tue 10:45	9	Automatic mode	⌚
3	Heating element on	🔥	10	Pre-program mode	⌚
4	Comfort mode	☀️	11	Hourly programming	📊
5	Eco mode	ECO	12	Open Windows indicator	🪟
6	Anti-Frost mode	❄️	13	Energy consumption indicator	📊
7	Locked keypad	🔒			

4.3. Turn On and Off

To turn the product on press the button once. To turn off press the button again. When you turn the product on for the first time, it will ask you to set the date and time. Use the buttons to select the correct time and press the button to confirm. Then use the buttons to select the correct minutes and press . Use the buttons again to select the correct day and press the button to confirm.





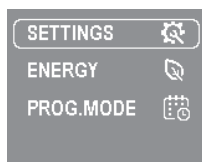



4.4. Submenu configuration

Press the button to access the configuration menu. Then use the buttons to navigate to **settings**. Press the button to access.



4.4.1. Set the day and time

To set the day or time select the **CLOCK** option.

Use the   buttons to select the correct time and press the  button to confirm. Then use the   buttons to select the correct minutes and press the  button to confirm. Then use the   buttons to select the correct day and press the  button to confirm.

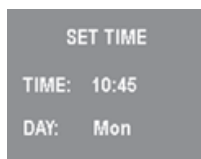

4.4.2. Adjust brightness

This function allows you to adjust the brightness when the product is on or in standby.

To adjust the brightness, select **BACKLIGHT**. With the   buttons you can turn the brightness up or down. Press the  button to confirm.

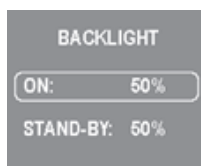

4.4.3. Language

This function allows you to change the language of the product.

To change the language, select **LANGUAGE**. Use the   buttons to select the correct one and press .





4.4.4. Firmware

This option displays the current software version and the release date. To see this press the **FIRMWARE** option.



4.5. Locking touchpad

To lock the keypad, press and hold the   buttons together for 3 seconds. The  symbol will appear to the right of the screen.

To unlock the keypad, press and hold the   buttons together for 3 seconds. The  symbol will disappear from the right of the screen.

4.6. Selecting Manual, Automatic or Pilot mode* (*Not available in this product)

To select **MANUAL**, **AUTO**, **PRE-PROGRAMMING** or **PILOT MODE**, access the programming menu by pressing the  button.



MODE – allows you to select between MANUAL or AUTOMATIC mode.

PRE-PROGRAMS – allows you to select one of the 4 default programming schedules.

USER PROGRAM – allows you to edit or create programming.

PILOT WIRE – allows you to activate external control of the product via the pilot wire (not available).

4.6.1. MANUAL mode

























When Manual mode is selected, the screen will show: the temperature, the manual icon , the comfort/eco/anti-frost icon, consumption indicator and time and day of the week.

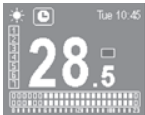



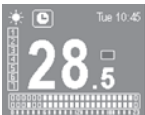

In Manual mode you can choose a temperature and the corresponding icon will be displayed on the screen according to the ranges set in the table below:

COMFORT	19 - 30 °C
ECO	7.5 - 18.5 °C
ANTI-FROST	7 °C





If you want to create your own programming:

<p>STEP 1</p> <p>1. Select COMFORT:</p> <p>Temperature between: 19 – 30°C.</p> <p>Use the   buttons to adjust the temperature. Press  to confirm.</p> <p>2. Select ECO:</p> <p>Temperature between: 7.5 – 18.5°C.</p> <p>Use the   buttons to adjust the temperature. Press  to confirm.</p> <p>3. Select ANTIFROST or OFF:</p> <p>Between: 7°C – OFF.</p> <p>Use the   buttons to adjust the temperature. Press  to confirm.</p>	  
<p>STEP 2</p> <p>1. Select the days:</p> <p>You can select the days to include in programming by a short press on the  button.</p> <p>The days marked must be highlighted by a box.</p> <p>Use the   buttons to move between the days. Press  after day 7 to go to the next step.</p>	
<p>STEP 3</p> <p>1. Select the programming mode for the hours:</p> <p>Use the   buttons to move between the hours. Select a programming mode (COMFORT / ECO / ANTI-FROST) for each hour using the  button. One press will select COMFORT, another press for ECO and a third press selects ANTI-FROST.</p> <p>a. In the top right it will indicate which hour you are programming.</p> <p>b. In the left side it will show you the days selected.</p> <p>c. The programming bar will show.</p> <p>I. COMFORT mode: 2 filled squares </p> <p>II. ECO mode: bottom filled square </p> <p>III. ANTI-FROST/OFF mode: 2 empty squares </p> <p>Once you have programmed a mode for every hour, press  to confirm and save your programming</p>	

4.7. Advanced features of the harmoni system

The harmoni system includes three advanced functions: Open Windows, Balance and Adaptative Mode. To activate or deactivate one of the functions below, press the  button to access the settings menu. Use the   buttons to scroll through the menu until you find the **POWER** submenu. Press the  button to access the submenu:



By accessing each of them, you can activate or deactivate its operation. Once selected, press the  button and use the   buttons to activate or deactivate the function. Press the  button once more to confirm the option.

4.7.1. OPEN WINDOWS function

The harmoni system has the OPEN WINDOWS  function activated as a default. This function is activated when the sensor detects that there has been a temperature decrease of 4°C in a period of 30 minutes. The OPEN WINDOWS mode is activated for two hours. When the OPEN WINDOWS mode is active, the radiator will be in ANTI-FROST mode at 7°C.

4.7.2. BALANCE function

The **BALANCE** submenu causes the product to work in Manual mode with a constant temperature of 19°C. Once selected, the product returns to the main screen, with the temperature set at 19°C and the **MANUAL** function icon activated.

4.7.3. ADAPTATIVE mode

Adaptive mode allows the product to learn how long it will take to heat the room to your desired temperature. It predicts the ideal time to activate the heating element to reach the temperature set, at exactly the right time you programmed, saving you time, energy and money.

5. Maintenance & Cleaning

The product does not require any type of maintenance. We recommend that all parts of the product are kept clean (behind, underneath, upper fins, etc.). Do not use any abrasive product on the aluminium. Clean it with a damp cloth and a pH neutral soap, and the control panel with a dry cloth.

European Directive 2012/19/UE

Under the European Directive 2012/19/UE on waste electrical and electronic equipment (WEEE), the product cannot be disposed in the usual council bins and containers. They must be separated to optimize the recovery and recycling of all of the components and materials and reducing the impact to human health and the environment. The symbol of the container crossed out over a horizontal line is marked on all of harmoni products to remind the consumer of the obligation to separate them on disposal. The consumer should contact the local authority or original point of sale to learn more about the correct disposal of this product.

6. Guarantee

In this section, we hereby describe the guarantee conditions which the buyer acquires on buying a new harmoni product. These conditions comply with all the rights construed in the national legislation in force, as well as any additional rights and guarantees which are offered by harmoni.

6.1. Any incident that you might detect in your harmoni product can be sorted by the product seller or quickly by the manufacturer. Please **contact harmoni by telephoning 01473 559088** for technical support.



You will need to state the product reference (located on the label indicating product features), serial number, proof of purchase and the type of incident at hand when contacting us so that we can check the guarantee. In addition, please attach a copy of the product invoice.

6.2. Harmoni guarantees that there are no material defects of design or manufacture at the time of original acquisition and guarantees the aluminium for a period of 120 months and 24 months for any electronic and electrical components.

6.3. If during the guarantee period, the product does not work correctly under normal use, and any design, material or manufacturing defect is found, harmoni will repair or substitute the product as it may see fit, in accordance with the terms and conditions as follows:

6.3.1. The guarantee is only applicable if the original guarantee is issued by the seller and when the said guarantee is filled in correctly including product reference, series number (marked on the product's label indicating technical features), purchase date and the seller's stamp.

Harmoni reserves the right to reject the guarantee service when this information has been removed or modified after the original product purchase.

6.3.2. The guarantee only applies to those cases that concern material, design and manufacturing defects, and under no circumstances covers damage to the product for the following reasons:

6.3.2.1 Incorrect use of the product, i.e. used for other purposes that are not construed as its normal use or for not respecting the instructions of use and maintenance given by harmoni as well as incorrect installation or use of the product that may not comply with the current technical standards of safety.

Corrosion caused by direct exposure to salt water is excluded from the guarantee. When the product is installed no more than 200m from the coast the guarantee for damages caused by corrosion the period will be reduced by 50%.

6.3.2.2 Any unauthorized repairs carried out by unauthorized technicians or opening of the product by unauthorized people.

6.3.2.3 Any accidents that are deemed outside the control of harmoni, such as lightning, fires, floods, public disorders, etc.

6.3.3. Any repairs or substitutions that are included in this guarantee do not allow any additions or new periods of guarantee.

6.3.4. Any repairs or substitutions covered under this guarantee must be parts that are functionally equivalent. The defective parts or parts removed or replaced shall become the property of harmoni.

6.4. The technical service of harmoni will advise you if you need to buy any parts not covered under the guarantee or out of guarantee.

6.5. This guarantee does not affect the buyer's legal rights stipulated in the current national legislation, nor affects those rights against the distributor or installer that could come forth in compliance with the purchase contract.

6.6. In the absence of a national legal legislation applicable, this guarantee shall prevail and may be construed as the buyer's only protection. Harmoni, its offices, distributors and installers may not be held responsible for any accidental damage that emerges due to infringement of any rules implicitly related to this product.

7. Information requirements for Erp Directive. Commission Regulation (EU) 2015/1188.

Item	Symbol	Unit	LU6H5440T	LU6H5660T	LU6H5680T	LU6H5100T	LU6H5130T	LU6H51540T
HEAT OUTPUT								
Nominal heat output	P_{nom}	kW	0,4	0,7	0,9	1,1	1,3	1,5
Minimum heat output (indicative)	P_{min}	kW	N.A.*	N.A.*	N.A.*	N.A.*	N.A.*	N.A.*
Maximum continuous heat output	$P_{max,c}$	kW	0,4	0,7	0,9	1,1	1,3	1,5
AUXILIARY ELECTRICITY CONSUMPTION								
At nominal heat output	e_{MAX}	kW	0,440	0,660	0,880	1,100	1,320	1,540
At minimum heat output	e_{MIN}	kW	0,440	0,660	0,880	1,100	1,320	1,540
In standby mode	e_{SB}	kW	0,0008	0,0008	0,0008	0,0008	0,0008	0,0008
TYPE OF HEAT OUTPUT/ROOM TEMPERATURE CONTROL (SELECT ONE)								
Single stage heat output and no room temperature control			-	-	-	-	-	-
Two or more manual stages, no room temperature control			-	-	-	-	-	-
With mechanic thermostat room temperature control			-	-	-	-	-	-
With electronic room temperature control			-	-	-	-	-	-
Electronic room temperature control plus day timer			-	-	-	-	-	-
Electronic room temperature control plus week timer			✓	✓	✓	✓	✓	✓
OTHER CONTROL OPTIONS (MULTIPLE SELECTIONS POSSIBLE)								
Room temperature control, with presence detection			-	-	-	-	-	-
Room temperature control, with open window detection			✓	✓	✓	✓	✓	✓
With distance control option			-	-	-	-	-	-
With adaptive start control			✓	✓	✓	✓	✓	✓
With working time limitation			✓	✓	✓	✓	✓	✓
With black bulb sensor			-	-	-	-	-	-
SEASONAL SPACE HEATING ENERGY EFFICIENCY	η_s		39,0%	39,0%	39,0%	39,0%	39,0%	39,0%
CONTACT DETAILS								
Harmoni Edison House Ransomes Europark Ipswich Suffolk IP3 9GU T:01473 559088								

*Not applicable

GUARANTEE CERTIFICATE

Please fill in the product details below:

PRODUCT REFERENCE NO.		PRODUCT SERIAL NO.	
PRODUCT NAME		PURCHASE DATE*	

Please fill in your details below:

FIRST NAME		SURNAME	
ADDRESS			
COUNTY			
POSTCODE		TELEPHONE NO.	
EMAIL			

In order to obtain the harmoni guarantee, an **authorised installer/electrician must** fill in the details below:

INSTALLER / ELECTRICIAN NAME			
INSTALLATION DATE*		PRODUCT NAME	
STAMP*		SIGNATURE	

PLEASE NOTE:

This Guarantee Certificate must be completed in full in order to obtain guarantee rights. The purchase date, installation date and the stamp are compulsory. Please keep the completed guarantee safe.

* Compulsory fields to be completed.

harmoni

Edison House
Edison Close
Ransomes Europark
Ipswich
Suffolk IP3 9GU

T: 01473 559088

harmoni cannot accept any responsibility for any errors in catalogues, brochures and other printed materials. harmoni reserves the right to alter its products without notice. This also applies to products already on order provided that such alterations can be made without subsequent changes to specifications already agreed. All trademarks in this material are the property of harmoni. harmoni and the harmoni logotypes are trademarks of Edison House Ltd. All rights reserved.

IMHRUK21V1